



Memoirs® Stately

Pedestal/Console Table Bathroom Sink

K-2269-8

Features

- 8" (203 mm) widespread faucet holes.
- Elegant rectangular basin.
- Overflow drain.
- Combines with the K-2267 pedestal to create the K-2268-8 Memoirs pedestal sink.
- Combines with the K-6880 or K-30003 console table legs to create a Memoirs console table.
- Coordinates with other products in the Memoirs collection.

Material

- Fireclay.

Installation

- Console table or pedestal.

Recommended Products/Accessories

- K-8998 P-Trap
- K-2267 Bathroom Sink Pedestal
- K-6880 Console Table Legs
- K-30003 Console Table Legs
- K-23726 Drain treatment
- K-23725 Cast iron cleaner



Codes/Standards









ASME A112.19.2/CSA B45.1

KOHLER® One-Year Limited Warranty

See website for detailed warranty information.

Available Colors/Finishes

Color tiles intended for reference only.

Color	Code	Description
	0	White
	96	Biscuit
	NY	Dune
	95	Ice™ Grey
	G9	Sandbar
	33	Mexican Sand™
	K4	Cashmere
	58	Thunder™ Grey
	7	Black Black™

1-800-4KOHLER (1-800-456-4537)

Kohler Co. reserves the right to make revisions without notice to product specifications.

For the most current Specification Sheet, go to www.kohler.com.

5-29-2021 17:04 - US/CA

THE BOLD LOOK
OF **KOHLER**®

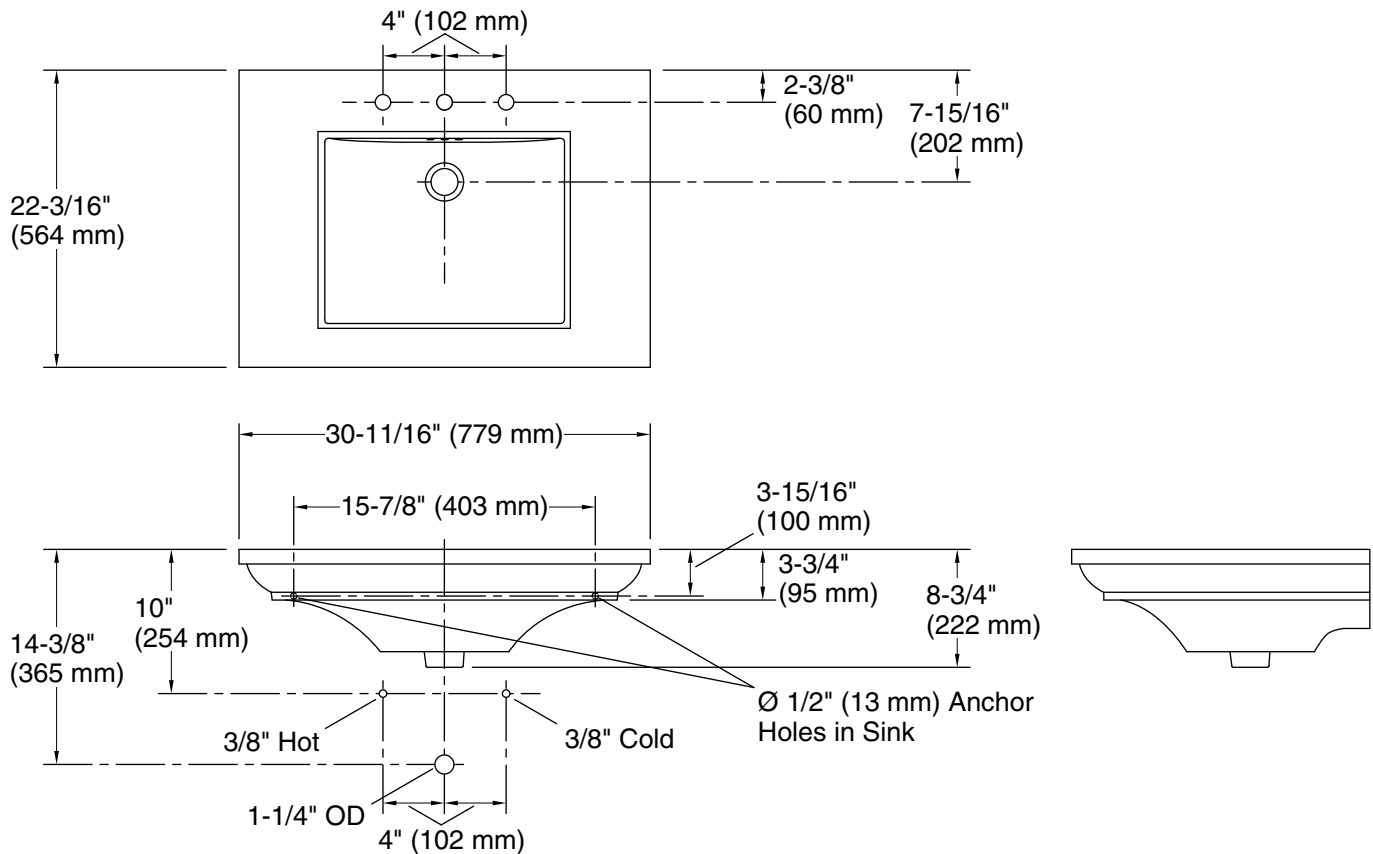

Technical Information

All product dimensions are nominal.

Bowl configuration:	Single
Installation:	Pedestal, Console table
Bowl area (Only):	Length: 19" (483 mm) Width: 14" (356 mm) Water depth: 5-1/2" (140 mm)
Number of deck holes:	3
Faucet hole spacing:	8" (203 mm)
Faucet hole(s):	1-3/8" (35 mm)
Drain hole:	1-3/4" (44 mm)

Notes

Install this product according to the installation instructions.

NOTICE: Countertop manufacturer or cutter must use the cutout template provided with the product, or a current one provided by Kohler Co. (call 1-800-4KOHLER). Kohler Co. is not responsible for cutout errors when the incorrect cutout template is used.