

► **Code Number**

3080053

► **Description**

Exposed Water Closet Flushometer, for floor mounted or wall hung top spud bowls.

► **Flush Cycle**

1.6 gpf/6.0Lpf

► **Specifications**

Quiet, Exposed, Diaphragm Type, Chrome Plated Closet Flushometer with the following features:

- ADA Compliant Metal Oscillating Non-Hold-Open Handle
- 1" I.P.S. Screwdriver Bak-Chek® Angle Stop
- Control Stop Plug
- Sweat Solder Adapter with Cover Tube
- Cast Wall Flange with Set Screw
- Vacuum Breaker Flush Connection
- Non-Hold-Open Handle and No External Volume Adjustment to Ensure Water Conservation
- Low Consumption flush accuracy controlled by Para-Flo™ Technology
- High Copper, Low Zinc Brass Castings for Dezincification Resistance

Valve Body, Cover, Tailpiece and Control Stop shall be in conformance with ASTM Alloy Classification for Semi-Red Brass. Valve shall be in compliance with the applicable sections of ASSE 1037 and ANSI/ASME 112.19.2.

► **Accessories (Sold Separately)**

See Accessories Section of the Sloan catalog for available accessories

► **Fixtures**

Consult factory for matching Sloan brand fixture options.

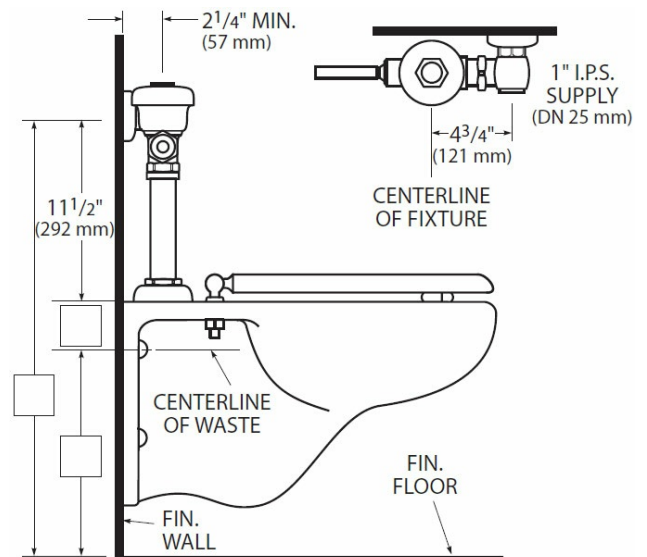
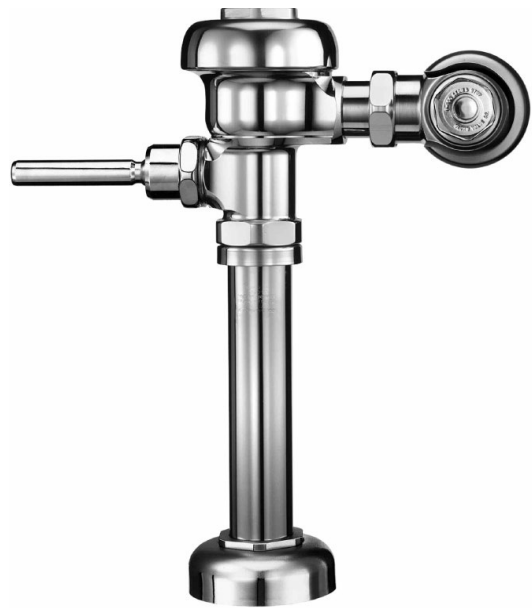

► **Compliance & Certifications**



Made In The
USA



This space for Architect/Engineer Approval