

Rectangular Undermount Lavatory

Product Specifications

Features

- Vitreous china
- Front overflow hole
- 8¼" Bowl depth
- Template supplied
- Mounting clips not included

Overall Size

- **Outer:** 545mm W x 355mm D x 210mm H 21½" W x 14" D x 8¼" H
- **Inner:** 495mm W x 305mm D x 160mm H 19½" W x 12" D x 6¼" H



Compliance Certifications

Meets or exceeds the following:

- IAPMO cUPC
- ASME A112.19.2 / CSA B45.1

LXS10022 Soft White
LXS10023 Matte Black
LXS10024 Slate Gray

Shipping

- Cube 1.85
- GW 20lbs

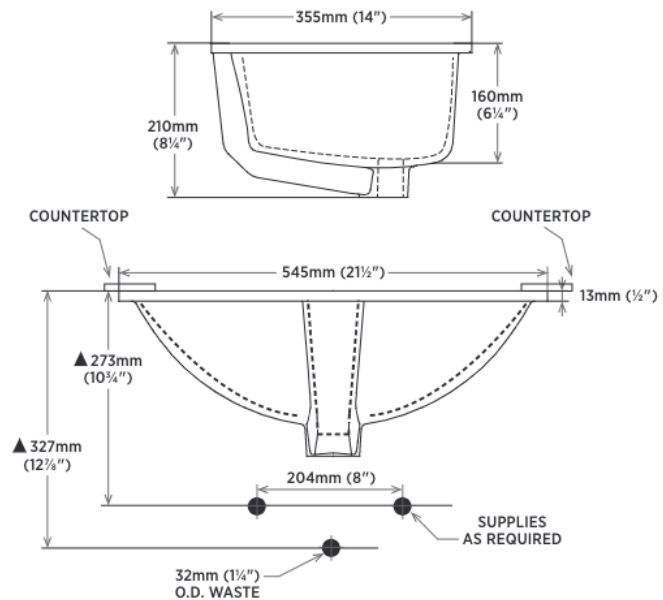
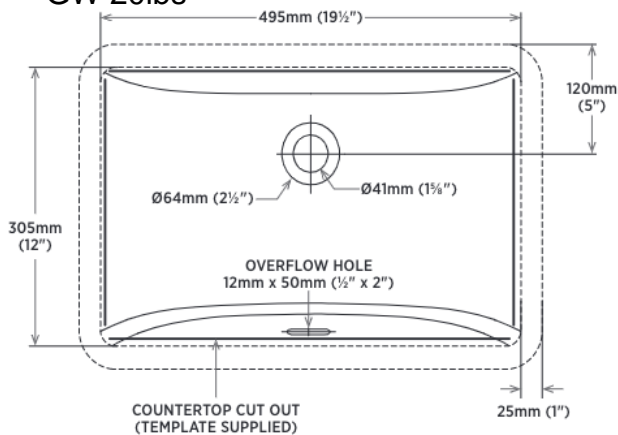

DETAIL OF MOUNTING CLIP

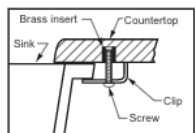

Note:
 ▲ Dimensions shown for location of supplies and "P" trap are suggested.

All dimensions listed are nominal. Luxart® reserves the right to make product and material changes at any time without notice.

Contact your sales representative for more information or visit our website at luxartcollection.com

