



Whitehaven®
 32-1/2" undermount single-bowl farmhouse kitchen sink
 K-5826

Features

- Fits minimum 33" (838 mm) base cabinet width.
- Single bowl.
- 9" (229 mm) depth provides generous workspace.
- Shortened apron allows sink to be used in most standard cabinetry or retrofitted to existing standard cabinetry.
- Self-Trimming® apron overlaps cabinet face for easy installation and beautiful results.
- Bowl slopes toward drain to minimize water pooling.
- Offset drain increases workspace in the sink and storage space underneath.

Material

- KOHLER® enameled cast iron.

Installation

- Cutout templates included.
- Undermount.

Recommended Products/Accessories

- K-8801 Sink drain and strainer with tailpiece
- K-8799 Sink drain and strainer basket
- K-23726 Drain treatment
- K-23725 Cast iron cleaner

Optional Products/Accessories

- K-6449 Stainless steel sink racks
- K-11352 Disposal Flange with Stopper
- K-9000 P-Trap

Included Components

- Additional Components:
- Cabinet face cutout template
 - Countertop cutout template



Codes/Standards







ASME A112.19.1/CSA B45.2

KOHLER® Enameled Cast Iron Kitchen and Bathroom Sink Lifetime Limited Warranty

See website for detailed warranty information.

Available Colors/Finishes

Color tiles intended for reference only.

Color	Code	Description
	0	White
	FF	Sea Salt™
	96	Biscuit
	NY	Dune
	95	Ice™ Grey
	58	Thunder™ Grey
	7	Black Black™
	DGB	Indigo Blue

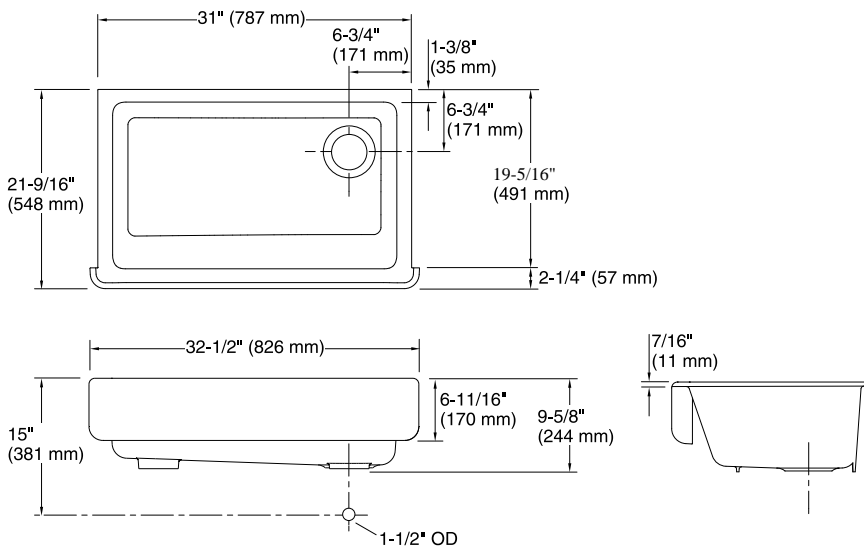

Technical Information

All product dimensions are nominal.

Bowl configuration:	Single
Installation:	Undermount
Min. base cabinet width:	33" (838 mm)
Bowl area:	Length: 27-3/4" (705 mm) Width: 18-1/16" (459 mm) Bowl depth: 9-5/8" (244 mm) Water depth: 9" (229 mm)
Drain hole:	3-5/8" (92 mm)
Template:	1214395-7, required, included 1214396-7, required, included

Notes

Install this product according to the installation instructions.

NOTICE: Countertop manufacturer or cutter must use the current product template available at www.kohler.com, or by calling 1-800-4KOHLER. Kohler Co. is not responsible for cutout errors when the incorrect cutout template is used.

IMPORTANT! The distance from the top edge of the cabinet to the top of the cabinet door must be at least 6-7/8" (175 mm) to install this sink.