

Submittal Package

viega

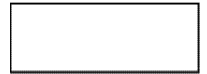

Viega MegaPress and MegaPressG Fitting System

- Chilled Water
- Hydronic Heating
- Fire Protection
- Low Pressure Steam
- Heating Fuel Oil
- Natural Gas
- Compressed Air

Viega... The global leader in plumbing, heating and pipe joining systems

301 N. Main, 9th Floor • Wichita, KS 67202 • Ph: 800-976-9819 • Fax: 316-425-7618 • www.viega.com

©2011, ProPress®, FostaPEX®, Seapress®, MegaPress®, MegaPressG® and Viega® are registered trademarks of Viega GmbH & Co. PureFlow®, Smart Connect®, Climate Panel®, Climate Mat®, Climate Trak®, MANABLOC®, Radiant Wizard®, S-no-Ice®, Snap Panel®, XL® and XL-C® are registered trademarks of Viega LLC. MiniBloc™, ProRadiant™, PolyAlloy™, SmartLoop™ and Zero Lead™ are trademarks of Viega LLC; GeoFusion™, ProPressG™ and ViegaPEX™ are trademarks of Viega GmbH & Co. KG.

Submittal Package

viiega

System Data Sheet

System Description

Viiega MegaPress and MegaPressG are safe, reliable, and economical steel pipe installation systems that use modern cold press connection technology for a wide assortment of more than 200 fittings in dimensions ranging from 1/2" to 2".

Pipe: Schedule 5 to schedule 40 Black steel pipe from 1/2" to 2" for Viiega MegaPress. Schedule 40 black pipe for Viiega MegaPressG.

Viiega Smart Connect feature: By means of the Smart Connect feature on Viiega MegaPress Systems fittings, an unpressed connection can be recognized by escaping water, or by a drop in pressure, when testing the system. Fitting connections without the Smart Connect feature may not leak initially; however, later they can unseat during system operations. When the fitting is pressed, the Smart Connect feature is reformed and a permanent, sealed, non-detachable, mechanical connection is created. Other systems without the Smart Connect feature may not leak initially; however, later they can unseat in future system operations. The Smart Connect feature is designed to protect from the potential risk of unpressed fittings.

Applications

All piping must comply with the ASTM A53, A195 and A795 standards. Viiega MegaPress and MegaPressG fittings are approved for installations in both above and below ground applications. Per code, local inspector approval must be obtained prior to installation below ground.

Operating Temperatures:

Viiega MegaPress: 0°F - 250°F
Viiega MegaPressG: -40F - 180F

Approved Applications:

- Hydronic heat
- Chilled water
- Compressed Air
- Non Medical Gases
- Fire Sprinkler
- Low Pressure Steam
- Vacuum
- Natural Gas
- LP Gas
- Fuel Oil

System Benefits

- Fast and Easy to Use
- Flameless
- Permanent Connections
- Wide Capacity from 1/2" to 2"
- Large Selection of Fittings
- Consistent Professional Appearance
- Less Equipment Required
- Environmentally Friendly Connection System
- Versatility of Fittings and Tools for Variety of Applications

Fittings

Viiega MegaPress and MegaPressG fittings are offered in 200+ configurations including: Elbows, Couplings, Reducers, Tees, Reducing Tees, Threaded Adapters and Unions.

Tools

RIDGID offers pressing tools for connecting MegaPress fittings.

- 330-C Corded Tool (1/2" to 2")
- 330-B Battery powered Tool (1/2" to 2")
- 320-E
- 400-E
- 1/2" to 4" fittings are pressed in 4-7 sec.

RIDGID Pressing Tools

Model	330C	330B
Volts	120v	14.4v Battery
Amps	5.2A	27.2A
Weight (w/out jaw)	9 lbs.	10 lbs.

History

Press technology has been used in Europe since the late 1980s and in the U.S. since the late 1990s for a variety of applications. Backed by two plumbing leaders with over 175 years of combined excellence.

Approvals and Certificates

CSA LC 4

TSSA/ASME B31

Compliant with

- ICC International Plumbing Code
- ICC International Mechanical Code
- UPC Uniform Plumbing Code
- UMC Uniform Mechanical Code
- International Fuel Gas Code
- NFPA 13, 13D, 13R, 31, 54 and 58
- ASME B31

Contact your local Viiega representative for details on local approvals

For more information on RIDGID products contact:

Ridge Tool Company
400 Clark Street, Elyria, Ohio 44036
Demos, Literature: 800-769-7743
Technical inquiries: 800-519-3456
Availability: 888-743-4333
Web: www.ridgid.com

Viiega... The global leader in plumbing, heating and pipe joining systems

301 N. Main, 9th Floor • Wichita, KS 67202 • Ph: 800-976-9819 • Fax: 316-425-7618 • www.vieiga.com

©2011, ProPress®, FostaPEX®, Seapress®, MegaPress®, MegaPressG® and Viiega® are registered trademarks of Viiega GmbH & Co. PureFlow®, Smart Connect®, Climate Panel®, Climate Mat®, Climate Trak®, MANABLOC®, Radiant Wizard®, S-no-Ice®, Snap Panel®, XL® and XL-C® are registered trademarks of Viiega LLC. MiniBloc™, ProRadiant™, PolyAlloy™, SmartLoop™ and Zero Lead™ are trademarks of Viiega LLC; GeoFusion™, ProPressG™ and ViiegaPEX™ are trademarks of Viiega GmbH & Co. KG.

Submittal Package

viega

Dimensional Documentation

Steel Elbow 90° P x P

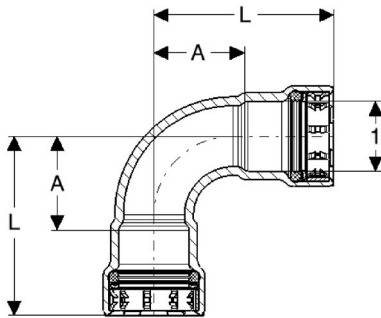

MODEL - 4816 MegaPress Stock Code	MODEL - 6616 MegaPressG Stock Code	Size	A (in)	L (in)
25200	25201	1/2"	1 1/8	2 1/4
25205	25206	3/4"	1 3/8	2 1/2
25210	25211	1"	1 3/4	3 1/8
25215	25216	1-1/4"	2	3 7/8
25220	25221	1-1/2"	2 1/4	4 1/8
25225	25226	2"	2 3/4	4 3/4

Steel Elbow 45° P x P

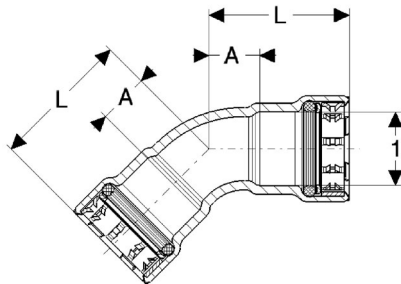

MODEL - 4826 MegaPress Stock Code	MODEL - 6626 MegaPressG Stock Code	Size	A (in)	L (in)
25230	25231	1/2"	5/8	1 5/8
25235	25236	3/4"	3/4	1 7/8
25240	25241	1"	7/8	2 1/4
25245	25246	1-1/4"	1	2 3/4
25250	25251	1-1/2"	1 1/8	3
25255	25256	2"	1 3/8	3 1/4

Steel Tee P x P x P

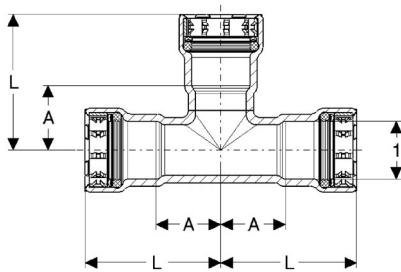

MODEL - 4818 MegaPress Stock Code	MODEL - 6618 MegaPressG Stock Code	Size	A (in)	L (in)
25300	25301	1/2"	1	2
25305	25306	3/4"	1 1/8	2 1/4
25310	25311	1"	1 1/4	2 5/8
25315	25316	1-1/4"	1 3/8	3 1/4
25320	25321	1-1/2"	1 5/8	3 1/2
25325	25326	2"	1 3/4	3 3/4

Viega... The global leader in plumbing, heating and pipe joining systems

301 N. Main, 9th Floor • Wichita, KS 67202 • Ph: 800-976-9819 • Fax: 316-425-7618 • www.viega.com

©2011, ProPress®, FostaPEX®, Seapress®, MegaPress®, MegaPressG® and Viega® are registered trademarks of Viega GmbH & Co. PureFlow®, Smart Connect®, Climate Panel®, Climate Mat®, Climate Trak®, MANABLOC®, Radiant Wizard®, S-no-Ice®, Snap Panel®, XL® and XL-C® are registered trademarks of Viega LLC. MiniBloc™, ProRadiant™, PolyAlloy™, SmartLoop™ and Zero Lead™ are trademarks of Viega LLC; GeoFusion™, ProPressG™ and ViegaPEX™ are trademarks of Viega GmbH & Co. KG.

Submittal Package

viega

Steel Reducing Tee P x P x P

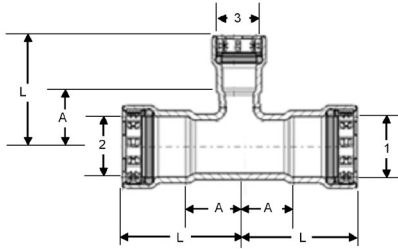

MODEL - 4818	MODEL - 6618	Size			A (in)	A1 (in)	L (in)	L1 (in)
MegaPress	MegaPressG							
Stock Code	Stock Code	1	2	3				
25330	25331	3/4" x 3/4" x 1/2"			1 1/8	1 1/8	2 1/4	2 1/8
25335	25336	1" x 1" x 1/2"			1 1/4	1 1/4	2 5/8	2 1/4
25340	25341	1" x 1" x 3/4"			1 1/4	1 1/4	2 5/8	2 3/8
25360	25361	1-1/2" x 1-1/2" x 1/2"			1 5/8	1 1/2	3 1/2	2 1/2
25365	25366	1-1/2" x 1-1/2" x 3/4"			1 5/8	1 1/2	3 1/2	2 5/8
25370	25371	1-1/2" x 1-1/2" x 1"			1 5/8	1 1/2	3 1/2	2 7/8
25375	25376	1-1/2" x 1-1/2" x 1-1/4"			1 5/8	1 1/2	3 1/2	3 3/8
25380	25381	2" x 2" x 1/2"			1 3/4	1 3/4	3 3/4	2 7/8
25385	25386	2" x 2" x 3/4"			1 3/4	1 3/4	3 3/4	3
25390	25391	2" x 2" x 1"			1 3/4	1 3/4	3 3/4	3 1/8
25395	25396	2" x 2" x 1-1/4"			1 3/4	1 3/4	3 3/4	3 5/8
25400	25401	2" x 2" x 1-1/2"			1 3/4	1 7/8	3 3/4	3 3/4

Steel Reducing Tee P x P x F NPT

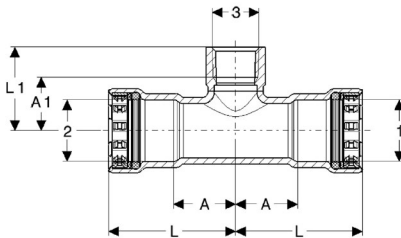

MODEL - 48172	MODEL - 66172	Size			A (in)	A1 (in)	L (in)	L1 (in)
MegaPress	MegaPressG							
Stock Code	Stock Code	1	2	3				
25405	25406	3/4" x 3/4" x 1/2"			1 1/8	1	2 1/4	1 1/2
25410	25411	1" x 1" x 1/2"			1 1/4	1 1/8	2 5/8	1 5/8
25415	25416	1" x 1" x 3/4"			1 1/4	1 1/8	2 5/8	1 5/8
25435	25436	1-1/2" x 1-1/2" x 1/2"			1 5/8	1 3/8	3 1/2	1 7/8
25440	25441	1-1/2" x 1-1/2" x 3/4"			1 5/8	1 3/8	3 1/2	1 7/8
25455	25456	2" x 2" x 1/2"			1 3/4	1 5/8	3 3/4	2 1/8
25460	25461	2" x 2" x 3/4"			1 3/4	1 5/8	3 3/4	2 2/8

Steel Adapter P x M NPT

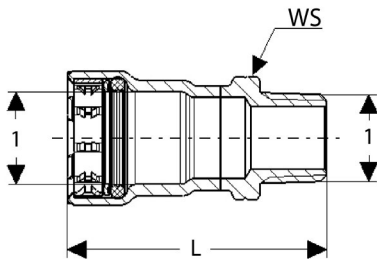

MODEL - 4811	MODEL - 6611	Size	L (in)	WS (in)
MegaPress	MegaPressG			
Stock Code	Stock Code	1		
25100	25101	1/2"	2 1/2	1 1/8
25105	25106	3/4"	2 5/8	1 1/4
25110	25111	1"	2 7/8	1 5/8
25115	25116	1-1/4"	3 5/8	1 3/4
25120	25121	1-1/2"	3 3/4	2 1/8
25125	25126	2"	3 7/8	2 3/4

Viega... The global leader in plumbing, heating and pipe joining systems

301 N. Main, 9th Floor • Wichita, KS 67202 • Ph: 800-976-9819 • Fax: 316-425-7618 • www.viega.com

©2011, ProPress®, FostaPEX®, Seapress®, MegaPress®, MegaPressG® and Viega® are registered trademarks of Viega GmbH & Co. PureFlow®, Smart Connect®, Climate Panel®, Climate Mat®, Climate Trak®, MANABLOC®, Radiant Wizard®, S-no-Ice®, Snap Panel®, XL® and XL-C® are registered trademarks of Viega LLC. MiniBloc™, ProRadiant™, PolyAlloy™, SmartLoop™ and Zero Lead™ are trademarks of Viega LLC; GeoFusion™, ProPressG™ and ViegaPEX™ are trademarks of Viega GmbH & Co. KG.

Submittal Package

viega

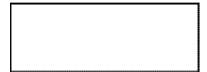

Steel Adapter P x F NPT

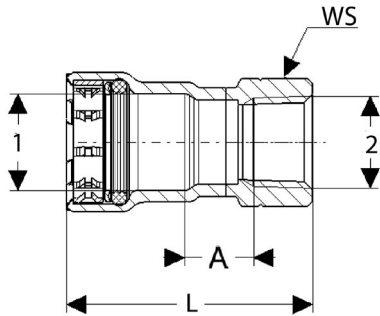

MODEL - 4812	MODEL - 6612	Size	A (in)	L (in)	WS (in)
MegaPress	MegaPressG				
Stock Code	Stock Code	1 2			
25130	25131	1/2"	5/8	2 1/4	1 1/8
25135	25136	3/4"	5/8	2 3/8	1 1/4
25140	25141	1"	5/8	2 5/8	1 5/8
25145	25146	1-1/4"	3/4	3 1/4	1 3/4
25150	25151	1-1/2"	3/4	3 3/8	2 1/8
25155	25156	2"	3/4	3 3/8	2 3/4

Steel Adapter Reducing P x F NPT

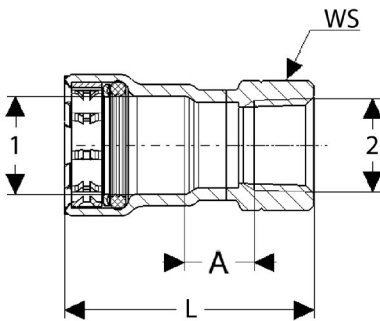

MODEL - 4812	MODEL - 6612	Size	A (in)	L (in)	WS (in)
MegaPress	MegaPressG				
Stock Code	Stock Code	1 2			
25575	25576	3/4" x 1/2"	5/8	2 3/8	1 1/8
25585	25586	1" x 3/4"	3/4	2 5/8	1 1/4
25600	25601	1-1/4" x 1"	3/4	3 1/4	1 5/8
25620	25621	1-1/2" x 1-1/4"	7/8	3 3/8	1 3/4
25645	25646	2" x 1-1/2"	3/4	3 3/8	2 1/8

Steel Coupling P x P With Stop

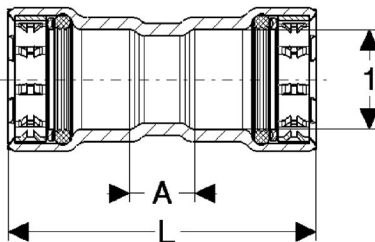

MODEL - 4815	MODEL - 6815	Size	A (in)	L (in)
MegaPress	MegaPressG			
Stock Code	Stock Code	1		
25000	25001	1/2"	5/8	2 3/4
22005	22009	3/4"	5/8	3
25010	25011	1"	5/8	3 1/4
25015	25016	1-1/4"	3/4	4 3/8
25020	25021	1-1/2"	1	4 5/8
25025	25026	2"	3/4	4 3/4

Viega... The global leader in plumbing, heating and pipe joining systems

301 N. Main, 9th Floor • Wichita, KS 67202 • Ph: 800-976-9819 • Fax: 316-425-7618 • www.viega.com

©2011, ProPress®, FostaPEX®, Seapress®, MegaPress®, MegaPressG® and Viega® are registered trademarks of Viega GmbH & Co. PureFlow®, Smart Connect®, Climate Panel®, Climate Mat®, Climate Trak®, MANABLOC®, Radiant Wizard®, S-no-Ice®, Snap Panel®, XL® and XL-C® are registered trademarks of Viega LLC. MiniBloc™, ProRadiant™, PolyAlloy™, SmartLoop™ and Zero Lead™ are trademarks of Viega LLC; GeoFusion™, ProPressG™ and ViegaPEX™ are trademarks of Viega GmbH & Co. KG.

Submittal Package

viega

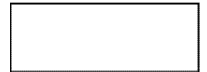

Steel Coupling P x P No Stop

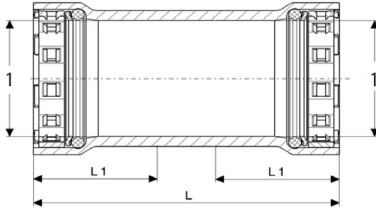

MODEL - 48155	MODEL - 66155	Size	L (in)	L 1 (in)
MegaPress	MegaPressG			
Stock Code	Stock Code	1		
25030	25031	1/2"	2 11/16	1 1/16
25035	25036	3/4"	2 15/16	1 3/16
25040	25041	1"	3 5/16	1 3/8
25045	25046	1-1/4"	4 3/8	1 13/16
25050	25051	1-1/2"	4 11/16	1 7/8
25055	25056	2"	4 3/4	1 15/16

Steel Reducer FTG x P

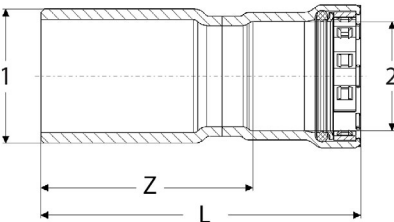

MODEL - 48151	MODEL - 66151	Size	Z (in)	L (in)
MegaPress	MegaPressG			
Stock Code	Stock Code	1 2		
26000	26001	3/4" x 1/2"	1.890	2.961
26005	26006	1" x 1/2"	2.177	3.248
26010	26011	1" x 3/4"	2.110	3.268
26015	26016	1-1/4" x 1"	2.650	3.996
26020	26021	1-1/2" x 3/4"	3.004	4.161
26025	26026	1-1/2" x 1"	2.827	4.173
26030	26031	1-1/2" x 1-1/4"	2.728	4.547
26035	26036	2" x 1"	3.161	4.508
26040	26041	2" x 1-1/4"	3.063	4.882
26045	26046	2" x 1-1/2"	3.012	4.882

Steel Union P x P

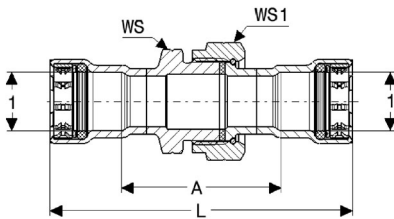

MODEL - 4860	MODEL - 6660	Size	A (in)	L (in)	WS (in)	WS1 (in)
MegaPress	MegaPressG					
Stock Code	Stock Code	1				
25700	25701	1/2"	2 3/8	4 1/2	1 3/8	1 5/8
25705	25706	3/4"	2 3/4	5	1 3/4	2
25710	25711	1"	2 5/8	5 3/8	2	2 1/8
25715	25716	1-1/4"	2 7/8	6 1/2	2	2 1/8
25720	25721	1-1/2"	3	6 3/4	2 1/2	2 3/4
25725	25726	2"	3 1/4	7 1/8	3 1/8	3 3/8

Viega... The global leader in plumbing, heating and pipe joining systems

301 N. Main, 9th Floor • Wichita, KS 67202 • Ph: 800-976-9819 • Fax: 316-425-7618 • www.viega.com

©2011, ProPress®, FostaPEX®, Seapress®, MegaPress®, MegaPressG® and Viega® are registered trademarks of Viega GmbH & Co. PureFlow®, Smart Connect®, Climate Panel®, Climate Mat®, Climate Trak®, MANABLOC®, Radiant Wizard®, S-no-Ice®, Snap Panel®, XL® and XL-C® are registered trademarks of Viega LLC. MiniBloc™, ProRadiant™, PolyAlloy™, SmartLoop™ and Zero Lead™ are trademarks of Viega LLC; GeoFusion™, ProPressG™ and ViegaPEX™ are trademarks of Viega GmbH & Co. KG.

Submittal Package

viEGA

Product Instructions



Read and understand all instructions for installing Viega MegaPress and MegaPressG fittings. Failure to follow all instructions may result in extensive property damage, serious injury, or death.

Note: Tubing shall be free of surface imperfections.

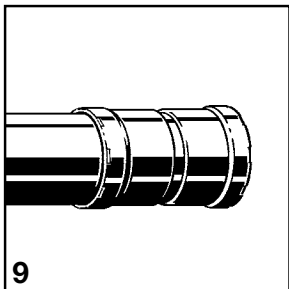
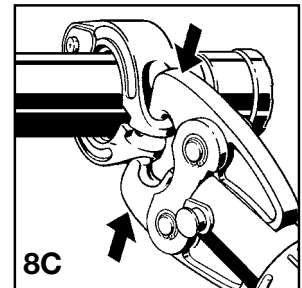
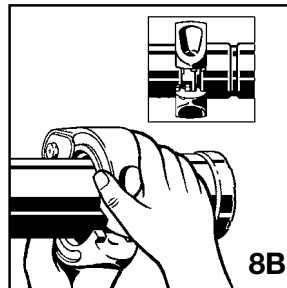
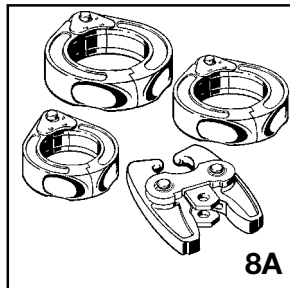
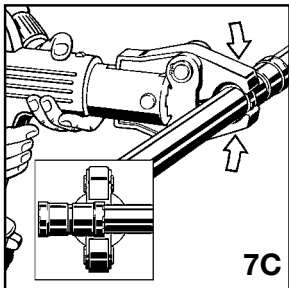
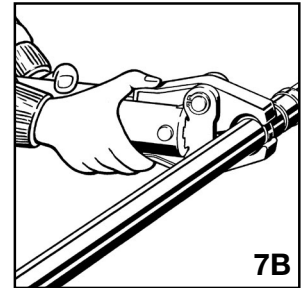
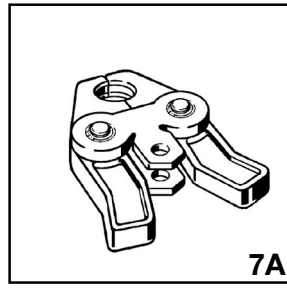
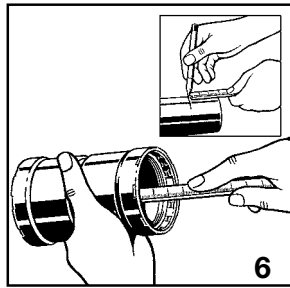
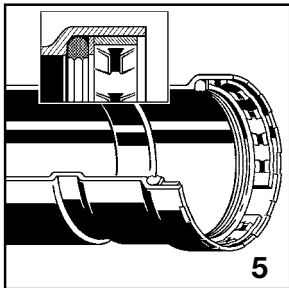
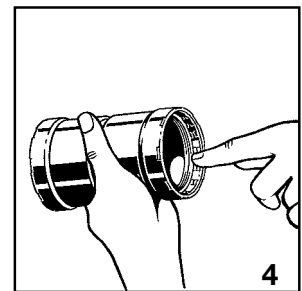
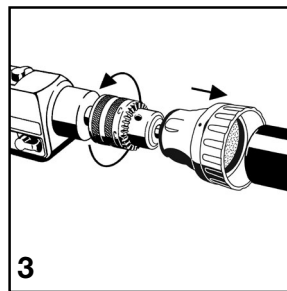
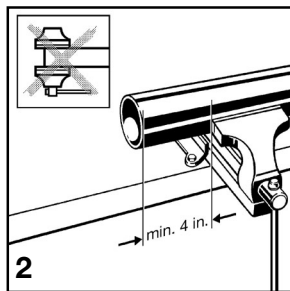
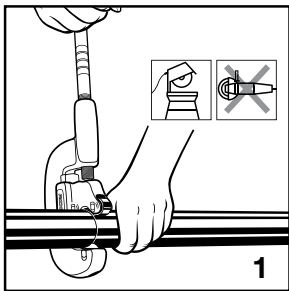

Viega... The global leader in plumbing, heating and pipe joining systems

301 N. Main, 9th Floor • Wichita, KS 67202 • Ph: 800-976-9819 • Fax: 316-425-7618 • www.viega.com

©2011, ProPress®, FostaPEX®, Seapress®, MegaPress®, MegaPressG® and Viega® are registered trademarks of Viega GmbH & Co. PureFlow®, Smart Connect®, Climate Panel®, Climate Mat®, Climate Trak®, MANABLOC®, Radiant Wizard®, S-no-Ice®, Snap Panel®, XL® and XL-C® are registered trademarks of Viega LLC. MiniBloc™, ProRadiant™, PolyAlloy™, SmartLoop™ and Zero Lead™ are trademarks of Viega LLC; GeoFusion™, ProPressG™ and ViegaPEX™ are trademarks of Viega GmbH & Co. KG.

Viega MegaPress and MegaPressG Fitting Systems

Viega MegaPress and MegaPressG is a carbon steel, cold press system designed for use in chilled water, hydronic heating, compressed air, fire sprinkler, fuel gas and heating oil applications.

Viega MegaPress fittings are designed for use in piping systems utilizing ASTM A53, A135 and A795 schedule 5 – schedule 40 black steel pipe.

Viega MegaPressG fittings are designed for use in fuel gas or fuel oil systems with ASTM A53 schedule 40 black pipe.

Standards:

- CSA LC4
- TSSA / ASME B31

Compliant with:

- Uniform Plumbing Code
- Uniform Mechanical Code
- International Plumbing Code
- International Mechanical Code
- NFPA 54
- NFPA 58
- International Fuel Gas Code
- ASME B31
- NFPA 13, 13D and 13R

Viega MegaPress and MegaPressG fittings are available in the following fitting configurations in size 1/2" – 2".

- P x P Coupling
- P x P No-stop coupling
- P x IPF NPT adapters
- P x IPF NPT Reducing adapter
- FTG x P Reducer
- P x IPM NPT adapter
- P x P 90° Elbow
- P x P 45° Elbow
- P x P x P Tee
- P x P x P Reducing Tee
- P x P x IPF NPT Tee
- P x P Union

Viega MegaPress fittings are provided with a factory installed EPDM sealing element, a 304 stainless steel separator ring and a 420 stainless steel grip ring approved for use in hydronic heating, compressed air, fire sprinkler and cooling water applications.



Viega MegaPressG fittings are provided with a factory installed HNBR sealing element, a 304 stainless steel separator ring and a 420 stainless steel grip ring and are CSA LC4 approved for fuel oil and fuel gas installations.

All Viega MegaPress and MegaPressG fittings are constructed with the patented Smart Connect feature. The Smart Connect feature is a quick and easy way for installers to identify connections that need pressing. Testing for leaks using the Smart Connect feature is not a replacement for testing to the requirements of local codes or standards.

Operating Temperatures:

Viega MegaPress Max.: 250°F

Viega MegaPressG Max.: -40 to 180°F

Viega MegaPress and MegaPressG systems are approved for underground use and must be protected against corrosion in accordance with NFPA 54 section 404.8, NACE Standard RP0169-2002 section 5, 2009 UPC Chapter 6 section 609.3.1, 2009 UMC Chapter 13 section 1312.1.3 and in a manner satisfactory to the local code official.

Recommended Tools:

- Ridgid 320E
- Ridgid 400E
- Ridgid MegaPress Pipe Prep Tool

Contact a local Viega representative for applications other than listed on this document.

Viega... The global leader in plumbing, heating and pipe joining systems

301 N. Main, 9th Floor • Wichita, KS 67202 • Ph: 800-976-9819 • Fax: 316-425-7618 • www.viega.com

©2011, ProPress®, FostaPEX®, Seapress®, MegaPress®, MegaPressG® and Viega® are registered trademarks of Viega GmbH & Co. PureFlow®, Smart Connect®, Climate Panel®, Climate Mat®, Climate Trak®, MANABLOC®, Radiant Wizard®, S-no-Ice®, Snap Panel®, XL® and XL-C® are registered trademarks of Viega LLC. MiniBloc™, ProRadiant™, PolyAlloy™, SmartLoop™ and Zero Lead™ are trademarks of Viega LLC; GeoFusion™, ProPressG™ and ViegaPEX™ are trademarks of Viega GmbH & Co. KG.

TD-MegaPress 1011