

Steam Generator Installation and Operation Instructions



*****CUSTOMER WARNINGS*****

- DO NOT USE THIS PRODUCT UNLESS YOU HAVE CONSULTED YOUR DOCTOR AND RECEIVED WRITTEN PERMISSION TO DO SO. USE OF THIS PRODUCT MAY BE HAZARDOUS TO YOUR HEALTH.
- STEAM IS HOT! DO NOT TOUCH OR GO NEAR THE STEAM HEAD FROM THE TIME THE UNIT IS “ON”, UP TO ONE HOUR FROM THE TIME THE UNIT IS OFF. SEVERE BURNS WILL OCCUR IF YOU COME IN CONTACT WITH THE STEAM HEAD OR STEAM EMITTING FROM THE STEAM HEAD.
- NEVER ATTEMPT TO FILL AROMA THERAPY RESERVOIR ON THE STEAM HEAD WHEN UNIT IS IN THE “ON” POSITION. SEVERE BURNS WILL OCCUR.
- DO NOT USE THERMASOL AROMA THERAPY OILS OR SKIN CARE PRODUCTS OR ANY PRODUCT IN CONJUNCTION WITH YOUR STEAM SUITE UNIT WITHOUT CONSULTING WITH YOUR ALLERGIST OR DOCTOR BEFORE USE. THESE PRODUCTS MAY BE HAZARDOUS TO YOUR HEALTH.
- YOUR SHOWER MAY BE A SLIP AND FALL HAZARD. CHECK WITH YOUR CONTRACTOR OR FLOORING MANUFACTURER REGARDING THE SAFE USE OF YOUR FLOORING IN A STEAM APPLICATION. SLIPPING AND FALLING INTO THE STEAM HEAD ITSELF OR INTO THE STREAM OF STEAM EMITTING FROM THE STEAM HEAD WILL CAUSE SERIOUS BURNS OR PHYSICAL INJURY.
- DO NOT USE STEAM ROOM WHILE UNDER THE INFLUENCE OF ALCOHOL OR DRUGS, AS THIS CAN BE HAZARDOUS TO YOUR HEALTH.
- IF YOU ARE FEELING UNCOMFORTABLE, DIZZY, FAINT, OR STARTING TO FALL ASLEEP, IMMEDIATELY EXIT THE STEAM ROOM.
- DO NOT USE STEAM ROOM IF YOU ARE UNDER THE AGE OF 16 UNLESS SUPERVISED BY AN ADULT.
- STEAM SUITE GENERATORS ARE FOR INDOOR USE ONLY. THEY SHOULD NEVER BE LOCATED OUTSIDE THE HOME.
- STEAM SUITE GENERATORS ARE NOT TO BE USED FOR SPACE HEATING PURPOSES.
- FOR SAFETY, SMOOTH OPERATION PRACTICE AND LIABILITY. IF YOU ARE A PLUMBER/INSTALLER, PLEASE ENSURE THIS OWNERS MANUAL & WARRANTY INFORMATION IS IN THE OWNER’S POSSESSION WITH SPECIFIC DELEGATION FOR THE PURPOSE OF COMPLETELY FAMILIARIZING ANY USERS WITH THIS OR ANY STEAM SUITE PRODUCT.
- FAILURE TO FOLLOW INSTALLATION INSTRUCTIONS SPECIFICALLY WILL CAUSE THE WARRANTY TO BE VOID.

Note: For better technical assistance and before contacting Technical Support, please have this model number and serial number ready

PLACE SERIAL # HERE

TECHNICAL AND WARRANTY SUPPORT ONLY: 1-800-585-7832

FOR ALL OTHER CUSTOMER SUPPORT PLEASE CONTACT YOUR DEALER



SIZING YOUR STEAM ROOM

1. Calculate the total volume of the enclosure. (Length x Width x Height = Total Volume).
2. Using the Volume total, simply select the kit that corresponds to the room size. For instance, a room 4' wide x 6' deep x 8 high equals 192 cubic feet.
3. Select a kit in your desired finish.

NOTE: for rooms taller than 8 feet in height you must go to the next larger size kit for every extra foot.

Steam Generator Model	Stm Rm Size (cu. ft.)	kW
PerfectSteam 8	140	8
PerfectSteam 10	240	10
PerfectSteam 12	395	11
PerfectSteam Plus 8	140	8
PerfectSteam Plus 10	240	10
PerfectSteam Plus 12	395	11

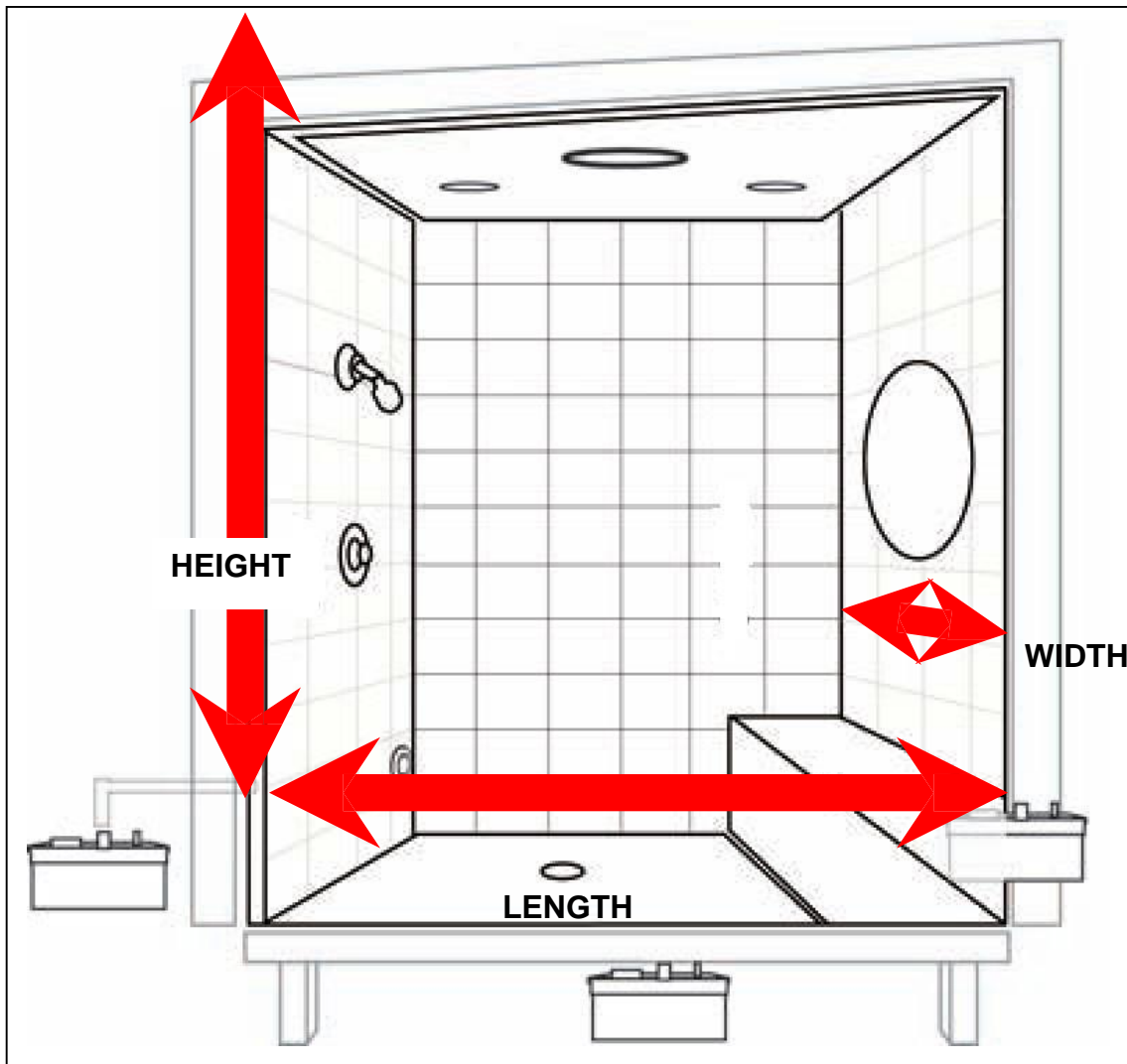

Steam Generator Installation Instructions

Tools Needed

- ✓ Pipe wrench
- ✓ Tubing cutter
- ✓ Wire cutters or wire strippers
- ✓ Adjustable wrench
- ✓ Screwdrivers (Phillips & regular)
- ✓ Solder & flux
- ✓ 7/8" & 1-1/16" masonry drill bits
- ✓ Drill motor
- ✓ Propane torch
- ✓ Other tools as required

Parts Enclosed

- ✓ Steam generator
- ✓ 50 foot control cord
- ✓ Steam head (Included)
- ✓ Waterfeeder screen kit
- ✓ Installation instructions w/ warranty form

Materials Needed

- ✓ Brass ball valve
- ✓ Pipe compound
- ✓ In-line filter (recommended)
- ✓ Wire (Hardwired units only)
- ✓ Wire cap nuts (Hardwired units only)
- ✓ Flex conduit (Hardwired units only)
- ✓ Brass or copper tee connection & plug
- ✓ Copper tubing or pipe with various fittings
- ✓ Silicone

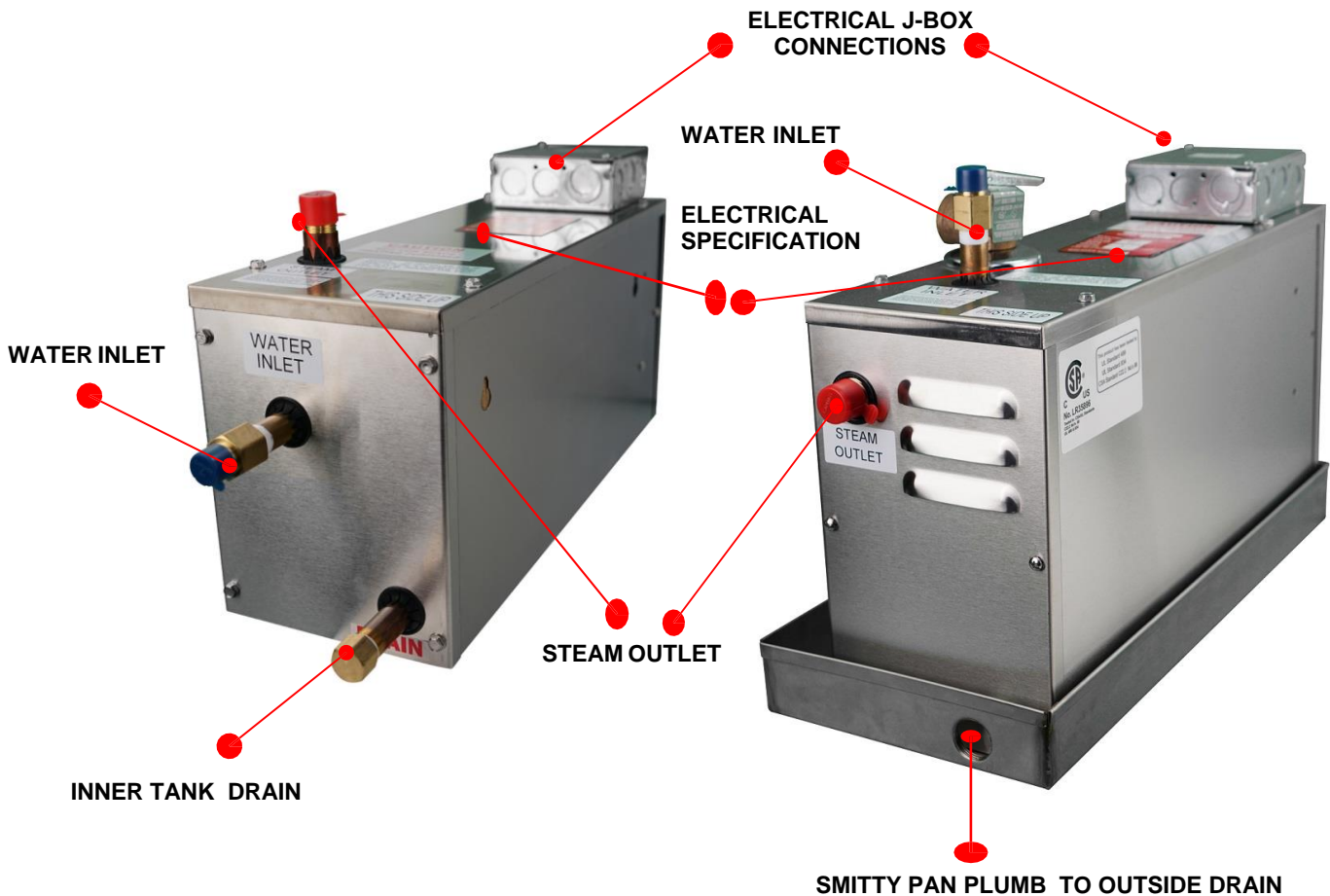

PerfectSteam Generator

PerfectSteam Plus Generator



NOTICE

YOU MUST ATTACH USER WARNING LABEL IN THE SHOWER NEXT TO THE CONTROL UPON COMPLETION OF INSTALLATION.

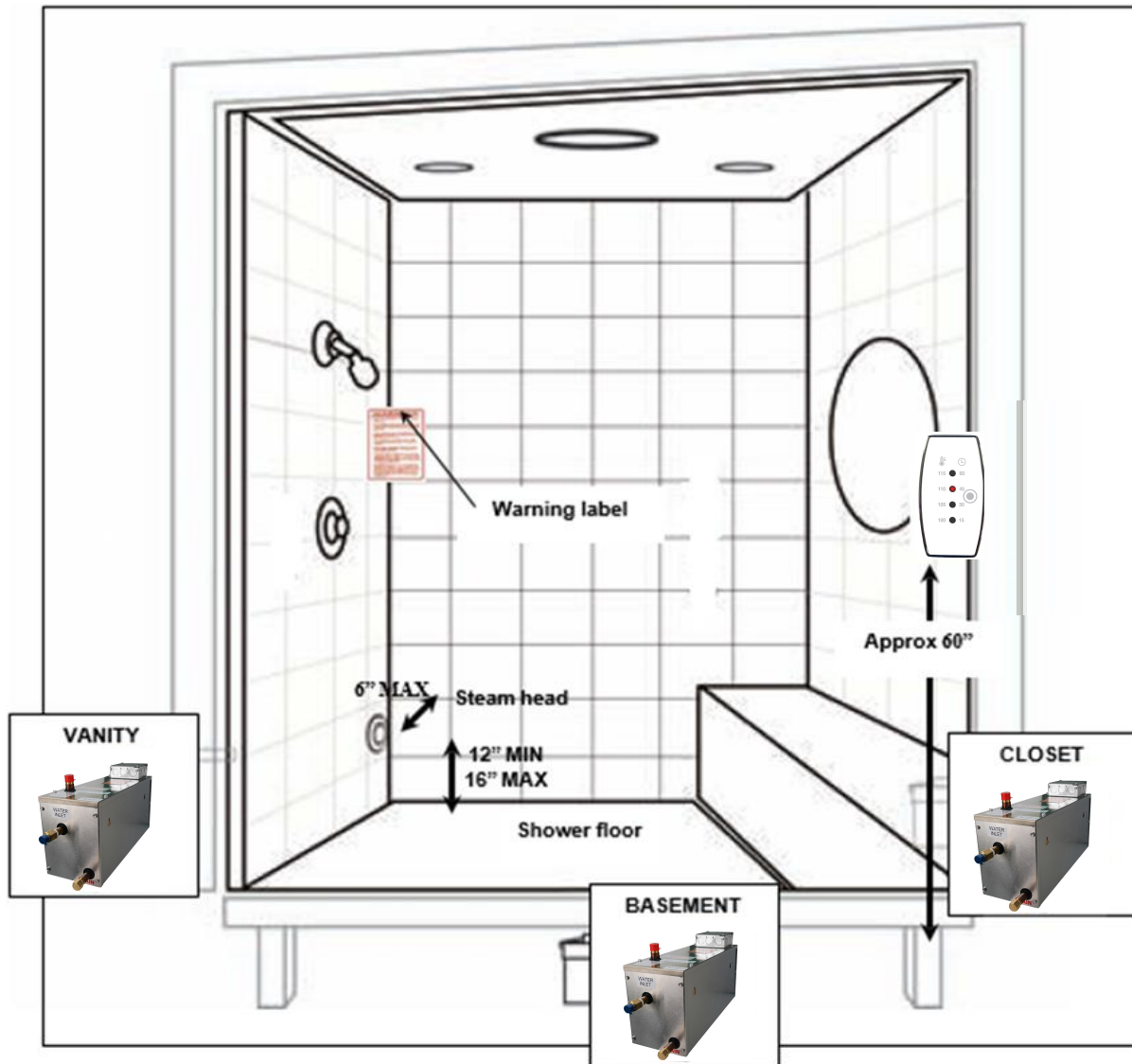

!!!! IMPORTANT !!!!

LOCATE THE STEAM HEAD 12" OFF THE SHOWER FLOOR OR BATHTUB RIM AND 6" FROM ANY CORNER. STEAM HEAD IS TO BE MOUNTED AS FAR AS POSSIBLE FROM TYPICAL BATHING POSITION (SEATED OR STANDING) AND AS FAR FROM CONTROL AS POSSIBLE WHILE MAINTAINING APPROXIMATELY A 60" CONTROL HEIGHT.

Requirements for Proper Installation

- 1.Ensure the enclosure to be used is vapor-proof. It should have a vapor-proof door that seals well so the steam does not escape. Make sure the wall, ceiling and the floor materials are okay to use with steam and hot condensation that any steam generator produces.
- 2.Use copper or brass fittings only. **(NEVER USE GALVANIZED OR IRON PIPE FITTINGS)**
- 3.MAXIMUM INLET WATER PRESSURE NOT TO EXCEED 70 P.S.I.
- 4.For the water inlet and steam outlet use a brass union for easy installation. You must Install the drain/spill pan under the unit for PerfectSteam models. PerfectSteam Plus models come pre-equipped with a drain pan. All drain pans must be plumbed to an approved drain.
- 5.**The generator must be upright, accessible and on a level surface** with all connections in the appropriate position; water inlet, steam outlet (see pg 3). Front and rear access panels must be unobstructed and allow for easy access.
- 6.Unit may be installed up to 50 feet away from shower area, in a dry well-ventilated area.
- 7.The steam line can run up, down, or horizontal; but cannot run down and then up. If it does, a steam trap may be produced at the low point blocking the flow of steam. Insulate the steam outlet piping if it exceeds 10 feet or is exposed to cold areas. NOTE: Use only steam rated insulation (225f min).
- 8.If unit is installed in a basement or attic, ensure that the unit and plumbing is well insulated and will not freeze.
- 9.**Do not** plumb a trap in the steam line or plumb the pressure relief valve into the steam line. Plumbing the pressure relief valve into the steam line can be hazardous, should the steam outlet be capped off or obstructed.
- 10.Pitch steam line back towards generator and avoid perfectly level plumbed steam lines.
- 11.Before connecting water line to the generator, flush water line into a five-gallon pail to remove any silt or other materials that may be in the line. Then install supplied screen kit. An in-line water filter is also recommended.
- 12.Make sure water is turned on to the unit before operating the unit.

Water Inlet Installation

1. The generator must be mounted on a level surface able to support a minimum of 50 pounds.
2. MAXIMUM INLET WATER PRESSURE TO BE NO LESS THAN 15 P.S.I. AND NOT TO EXCEED 70 P.S.I.
3. Connect a tee to the cold water line. Install copper pipe to the tee. An in-line filter is recommended.
4. Install a brass shut-off valve on the water inlet line in an accessible area prior to the recommended in-line water filter.
5. Before connecting water line to the generator, flush water line into a five-gallon pail to remove any silt or other materials that may be in the line. Then install supplied screen kit. An in-line water filter is also recommended.
6. Make the final connection and turn on water. All ThermaSol generators are equipped with an automatic water fill system. The water will stop after unit is filled.



STEAM HEAD / LINE INSTALLATION

Parts Enclosed

- ✓ Deluxe steam head
- ✓ Escutcheon

Tools Needed

- ✓ Pipe wrench
- ✓ 7/8" cutting tool
- ✓ Other tools as required



1. **IMPORTANT NOTE! LOCATE THE STEAM HEAD 12" OFF THE SHOWER FLOOR OR BATHTUB RIM AND 6" FROM ANY CORNER. STEAM HEAD IS TO BE MOUNTED FAR AS POSSIBLE FROM TYPICAL BATHING POSITION (SEATED OR STANDING) AND AS FAR FROM CONTROL AS POSSIBLE WHILE MAINTAINING APPROXIMATELY A 60" CONTROL HEIGHT.**
2. Drill a 7/8" diameter hole in the shower wall or wall above the bathtub for the steam outlet line.
3. Ensure the hole is sealed once made, this will prevent water intrusion behind the wall or tub.
4. Connect 1/2" brass union onto the steam outlet of generator.
5. Run a 1/2" copper pipe or tubing (free of any kinks) from the union to the 7/8" hole in wall.
6. Attach the steam head and escutcheon to the copper pipe. **CAUTION: Do not obstruct the steam line with any shut-off valves, plugs or caps. ALL STEAM SUITE generators are designed to build NO PRESSURE.**
7. The steam line can run up, down, or horizontal; but **cannot run down and then up**. If it does, a steam trap will be produced at the low point blocking the flow of steam. Insulate the steam outlet piping if the piping run exceeds 10 feet or is exposed to cold areas. **NOTE: Use steam rated insulation (225f min).**

WARNING: Avoid contact with steam head! It will burn you. Avoid direct contact with the steam coming out of the steam head! It is extremely hot! It will burn you!

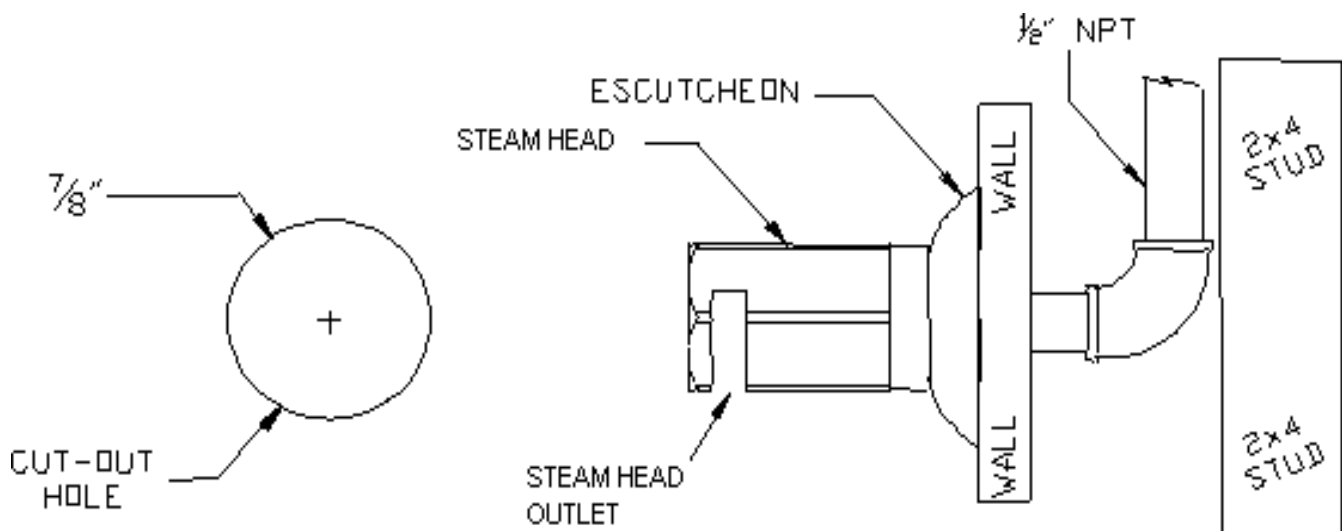

Electrical Installation

NOTE: All electrical wiring must be done per National/Local Electrical Codes.

Electrical Questions? Call (800) 585-7832 for Technical Support

Steam Suite requires that a licensed electrician perform all electrical work.

NOTE: USE COPPER WIRE ONLY.

Wire sizes recommended by NEC (2002 Version). Minimum wire temperature rating 90°C. Type THHN.

Steam Generator Model	Wire Gauge	Breaker Size	Stm Rm Size (cu. ft.)	kW
PerfectSteam 8	8	40	140	8
PerfectSteam 10	8	50	240	10
PerfectSteam 12	6	60	395	11
PerfectSteam Plus 8	8	40	140	8
PerfectSteam Plus 10	8	50	240	10
PerfectSteam Plus 12	6	60	395	11

1. Turn off all electricity to the working area at the main breaker panel!

2. Connect 240-volt SINGLE PHASE AC electrical lines to wires labeled 1 & 2 in junction box on the generator and an approved ground to the green safety grounding wire.

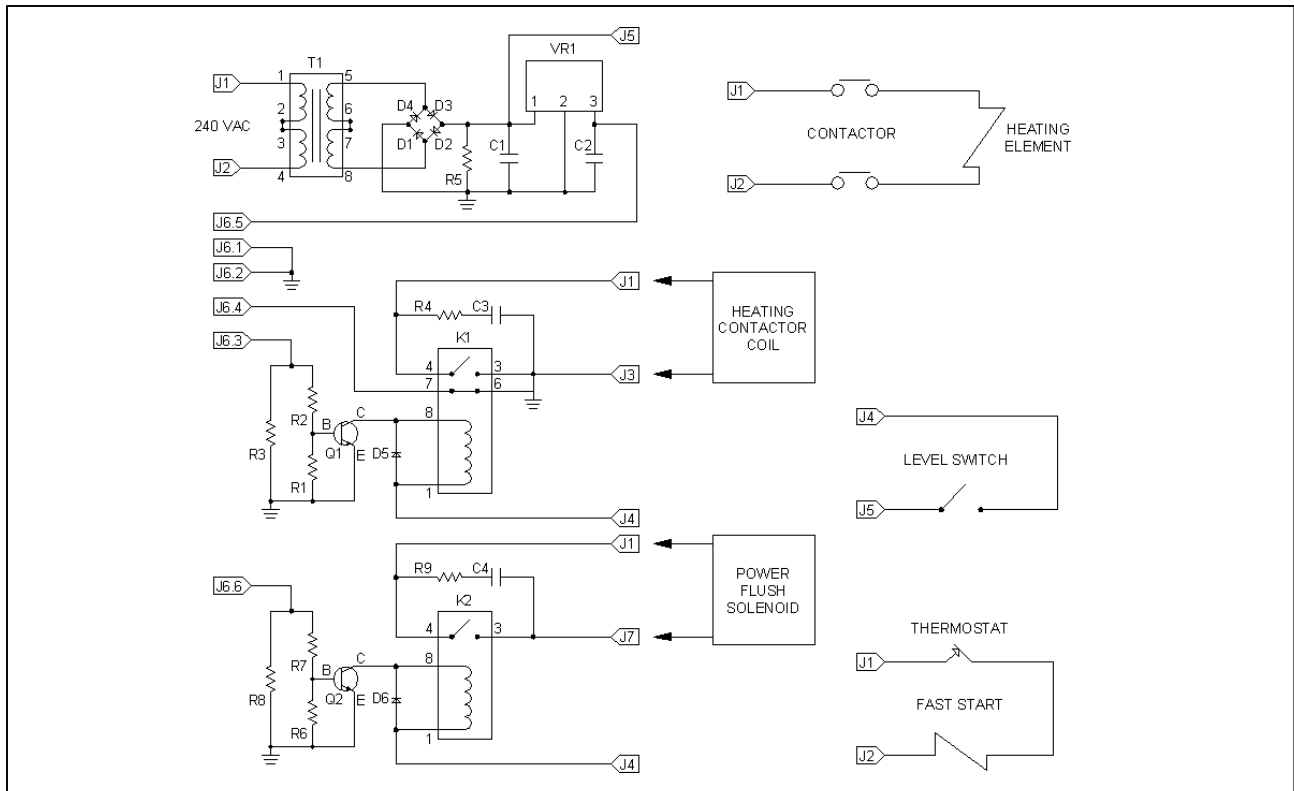

CONSUMER WARNING

DO NOT USE THIS PRODUCT UNLESS YOU HAVE **CONSULTED WITH YOUR DOCTOR** AND RECEIVED WRITTEN PERMISSION TO DO SO. USE OF THIS PRODUCT MAY BE HAZARDOUS TO YOUR HEALTH.

PLEASE CONSULT YOUR PHYSICIAN BEFORE USING. IF YOU ARE PREGNANT, ELDERLY, HAVE HIGH BLOOD PRESSURE, DIABETES, SUFFERING FROM HEART DISEASE, INTOXICATED, OR NOT IN GOOD HEALTH, DO NOT USE THIS STEAM BATH.

STEAM IS HOT! DO NOT TOUCH OR GO NEAR THE STEAMHEAD FROM THE TIME THE UNIT IS “ON”, UP TO ONE HOUR AFTER IT HAS SHUT OFF. SEVERE BURN WILL OCCUR IF YOU COME IN CONTACT WITH THE STEAMHEAD OR STEAM EMITTING FROM THE STEAMHEAD.

NEVER ATTEMPT TO FILL AROMA RESERVOIR ON THE STEAMHEAD WHEN UNIT IS IN THE **ON** POSITION. SEVERE BURNS WILL OCCUR.

DO NOT USE THERMASOL AROMATHERAPY OILS OR SKIN CARE PRODUCTS OR ANY PRODUCT ASSOCIATED WITH YOUR THERMASOL UNIT WITHOUT CONSULTING WITH YOUR ALLERGIST OR DOCTOR BEFORE USE. THESE PRODUCTS MAY BE HAZARDOUS TO YOUR HEALTH.

DO NOT USE STEAM ROOM WHILE UNDER THE INFLUENCE OF ALCOHOL OR DRUGS, AS THIS CAN BE HAZARDOUS TO YOUR HEALTH.

YOUR SHOWER MAY BE A **SLIP-AND-FALL HAZARD**. CHECK WITH YOUR CONTRACTOR OR FLOORING MANUFACTURER REGARDING THE SAFE USE OF YOUR FLOORING IN A STEAM APPLICATION. SLIPPING AND FALLING INTO THE STEAMHEAD ITSELF OR INTO THE STREAM OF STEAM EMITTING FROM THE STEAMHEAD WILL CAUSE SERIOUS BURNS, OR PHYSICAL INJURY.

IF YOU ARE FEELING **UNCOMFORTABLE, DIZZY, FAINT**, OR STARTING TO **FALL ASLEEP** IMMEDIATELY **EXIT** THE STEAM ROOM.

DO NOT USE STEAM ROOM IF YOU ARE UNDER THE AGE OF 16 UNLESS SUPERVISED BY AN ADULT.

THERMASOL STEAM BATH GENERATORS ARE **NOT** DESIGNED TO BE USED FOR **SPACE HEATING PURPOSES**. THERMASOL STEAM BATH GENERATORS ARE FOR **INDOOR USE ONLY**. THEY SHOULD NEVER BE LOCATED OUTSIDE THE HOME.



Steam Controller Installation and Operating Instructions



*****CUSTOMER WARNINGS*****

- DO NOT USE THIS PRODUCT UNLESS YOU HAVE CONSULTED YOUR DOCTOR AND RECEIVED WRITTEN PERMISSION TO DO SO. USE OF THIS PRODUCT MAY BE HAZARDOUS TO YOUR HEALTH.
- STEAM IS HOT! DO NOT TOUCH OR GO NEAR THE STEAM HEAD WHEN THE UNIT IS IN THE “ON” POSITION. SEVERE BURN WILL OCCUR IF YOU COME IN CONTACT WITH THE STEAM HEAD OR STEAM EMITTING FROM THE STEAM HEAD.
- NEVER ATTEMPT TO FILL AROMA THERAPY RESERVOIR ON THE STEAM HEAD WHEN UNIT IS IN THE “ON” POSITION. SEVERE BURNS WILL OCCUR.
- DO NOT USE THERMASOL AROMA THERAPY OILS OR SKIN CARE PRODUCTS OR ANY PRODUCT IN CONJUNCTION WITH YOUR UNIT WITHOUT CONSULTING WITH YOUR ALLERGIST OR DOCTOR BEFORE USE. THESE PRODUCTS MAY BE HAZARDOUS TO YOUR HEALTH.
- YOUR SHOWER MAY BE A SLIP AND FALL HAZARD CHECK WITH YOUR CONTRACTOR OR FLOORING MANUFACTURER REGARDING THE SAFE USE OF YOUR FLOORING IN A STEAM APPLICATION. SLIPPING AND FALLING INTO THE STEAM HEAD ITSELF OR INTO THE STREAM OF STEAM EMITTING FROM THE STEAM HEAD WILL CAUSE SERIOUS BURNS, OR PHYSICAL INJURY.

Note: Before contacting Customer Service for Technical Support, please have the model number and serial number (including all numbers and letters) located on the unit.

**TECHNICAL AND WARRANTY SUPPORT ONLY:
1-800-585-7832**



Steam Controller Installation Instructions

1. The steam control **MUST** be located inside the shower area.
2. Install the touch pad 4 to 6 feet from the floor inside the steam room. Drill a 1-1/16" hole in the wall.
3. Bring the control cable from the generator through the 1-1/16" hole. Using the coupler, connect the cable to the touch pad connector. Ensure the coupler is located higher in the wall than the control. Do not pinch, nail, or wedge the control cable. Any damage to the control cable could result in the control not working properly. If the control is not installed immediately, protect the end connector with tape or some other kind of shielding material.
4. Connect the other end of the control cable to the generator **BEFORE** turning power on to the generator.
5. Turn on both water and power to the generator.
6. Test the touch pad to ensure it is properly connected. If any problems arise, call (800) 585-7832.

7. THESE STEPS MUST BE TAKEN OR YOUR WARRANTY WILL BE VOID. Coat the entire control back with supplied waterproof silicon. Completely seal the control to the wall so moisture does not get behind it. Place the control on the wall pressing firmly. You may need to tape the control into place until the silicone dries. Be careful not to harm the wall and/or control with the tape. (Figure 1)

Let dry for 24 hours before using steam bath.

Failure to follow installation instructions specifically will cause the warranty to be void!

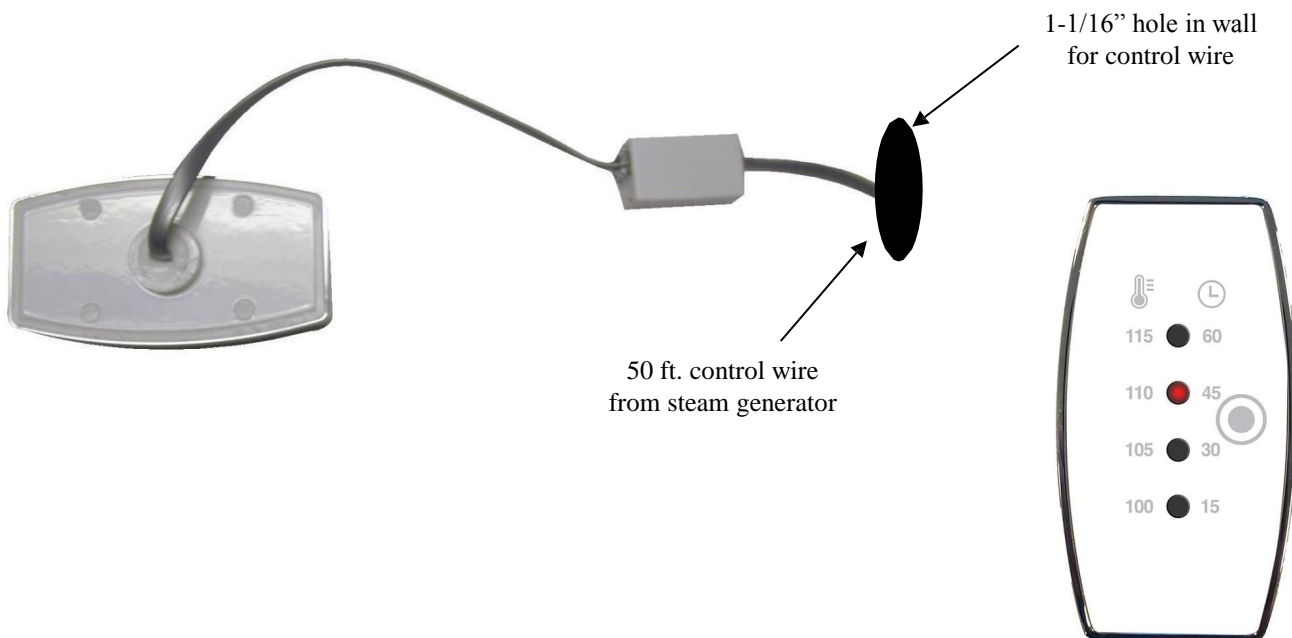

Steam Controller Operating Instructions

WARNING: Please consult your physician before using this steam bath if you are pregnant, elderly, have high blood pressure, diabetes, suffering from heart disease, intoxicated, or in poor health.

1. Starting Your Steam Bath. Press the “Control Button” momentarily to activate your steam bath session. Your control will come from the factory with a default setting of 60 minutes at 100°F (to change these settings move to steps 2 and 3) once the button is pressed you will see a green LED appear indicating the time to be set, four seconds will pass and a red LED will appear indicating the temperature to be set.

Note: Green LED's indicate the time and the red LED's indicate the temperature.

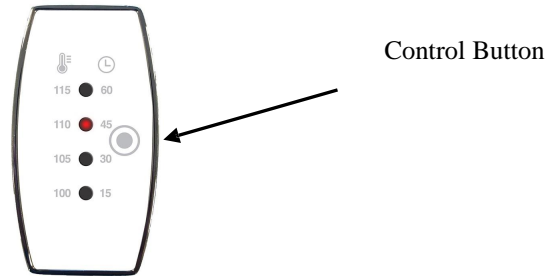

Figure 2

2. Changing Session Time. While the green LED is still flashing (within 4 seconds), momentarily press the “Control Button”. Repeat until the green LED associated with your desired time starts flashing. Once the desired time is flashing, wait 4 seconds and that time will be accepted by the control. (Figure 3)

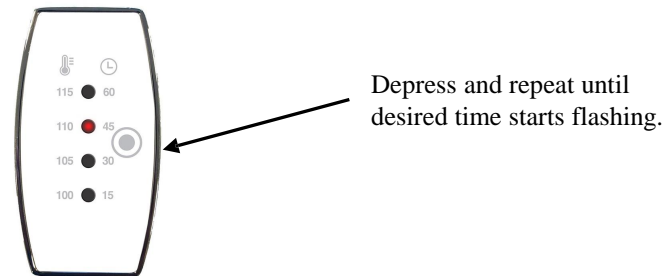

Figure 3

3. Changing Session Temperature. After the time has been selected, the red 100° LED will automatically start flashing. If this is the desired temperature, wait 4 seconds and that temperature will be accepted by the control and the generator will start. If a different temperature is desired, momentarily press the “Control Button”. Repeat until the red LED associated with your desired temperature starts flashing. Once the desired temperature is flashing, wait 4 seconds and that temperature will be accepted by the control and the generator will start. (Figure 4)

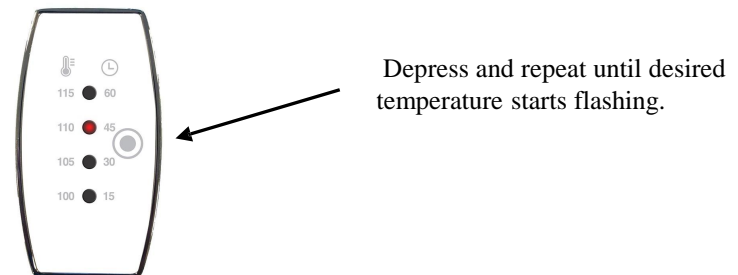

Figure 4



4. **Manual Power Off.** To manually power off the generator before the selected time has expired, press the “Control Button” once. The LED’s will go off and the generator will turn off. (Figure 5)

Auto Power Flush. To activate the powerflush cleaning system, turn the generator on by pressing the control button, wait 4 seconds for green LED to stop flashing, wait 4 seconds for red LED to stop flashing, then press and hold the on button for 7 seconds then let go. The led lights will alternate on and off in a top to bottom motion indicating that the cleaning system has been activated. Powerflush will begin in two minutes and the complete cycle will last 45 minutes.

Note: The steam control has a built in memory and will remember your time and temperature setting for the next session.

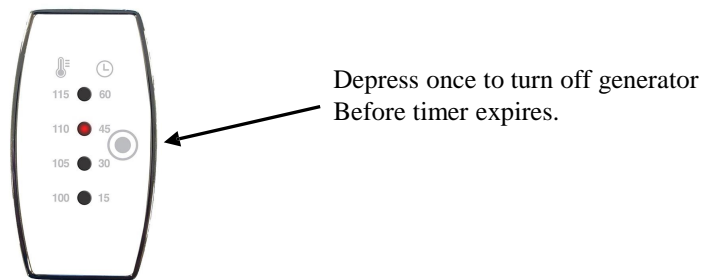

Figure 5

5. **Diagnostic Feature.** The steam control has a unique diagnostic feature. If there is a malfunction within the unit, it will alert you. The red 115° LED will flash when the low water sensor is activated, the red 110° LED will flash if the shower area exceeds 135°F, and the red 100° LED will flash if the control button becomes stuck. If any of these diagnostics happen the unit will shut down and lock out all user interfaces. To reset the unit, power will need to be reset at the breaker. Contact a Steam Services technician at (800) 585-7832 for further trouble shooting steps. (Figure 6)

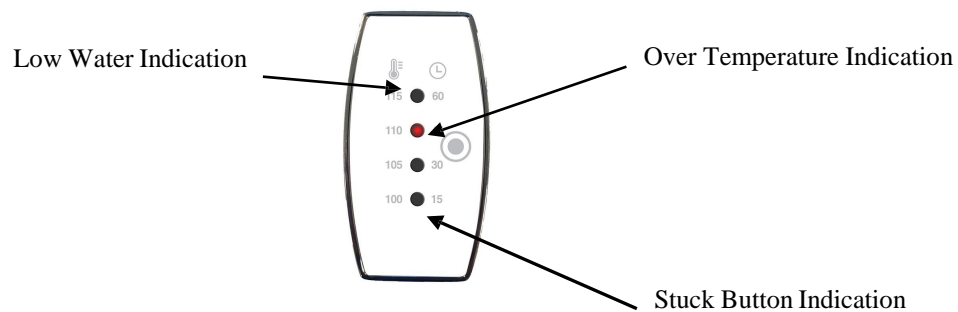

Figure 6

CONSUMER WARNING

WARNING

DO NOT USE THIS PRODUCT UNLESS YOU HAVE CONSULTED WITH YOUR DOCTOR AND RECEIVED WRITTEN PERMISSION TO DO SO. USE OF THIS PRODUCT MAY BE HAZARDOUS TO YOUR HEALTH.

WARNING

NEVER ATTEMPT TO FILL AROMA RESERVOIR ON THE STEAM HEAD WHEN UNIT IS IN THE ON POSITION. SEVERE BURNS WILL OCCUR.

WARNING

DO NOT USE THERMASOL AROMA THERAPY OILS OR SKIN CARE PRODUCTS OR ANY PRODUCT IN CONJUNCTION WITH YOUR THERMASOL UNIT WITHOUT CONSULTING WITH YOUR ALLERGIST OR DOCTOR BEFORE USE. THESE PRODUCTS MAY BE HAZARDOUS TO YOUR HEALTH.

WARNING

YOUR SHOWER MAY BE A SLIP AND FALL HAZARD CHECK WITH YOUR CONTRACTOR OR FLOORING MANUFACTURER REGARDING THE SAFE USE OF YOUR FLOORING IN A STEAM APPLICATION. SLIPPING AND FALLING INTO THE STEAM HEAD ITSELF OR INTO THE STREAM OF STEAM EMITTING FROM THE STEAM HEAD WILL CAUSE SERIOUS BURNS, OR PHYSICAL INJURY.

WARNING

STEAM IS HOT! DO NOT TOUCH OR GO NEAR THE STEAM HEAD FROM THE TIME THE UNIT IS "ON", UP TO ONE HOUR AFTER IT HAS SHUT OFF. SEVERE BURN WILL OCCUR IF YOU COME IN CONTACT WITH THE STEAM HEAD OR STEAM EMITTING FROM THE STEAM HEAD.

WARNING

DO NOT USE STEAM ROOM WHILE UNDER THE INFLUENCE OF ALCOHOL OR DRUGS, AS THIS CAN BE HAZARDOUS TO YOUR HEALTH.

WARNING

IF YOU ARE FEELING UNCOMFORTABLE, DIZZY, FAINT, OR STARTING TO FALL ASLEEP IMMEDIATELY EXIT THE STEAM ROOM.

WARNING

DO NOT USE STEAM ROOM IF YOU ARE UNDER THE AGE OF 16 UNLESS SUPERVISED BY AN ADULT.



PerfectSteam Generators 5 YEAR “NO QUESTIONS ASKED” – FACTORY WARRANTY

The manufacturer will repair the specific failure on your PerfectSteam generator manufactured after March 1, 2009, at its factory for 5 years. All expenses required to remove and send the unit to the factory, return and reinstall the unit is the responsibility of the owner.

PerfectSteam Plus Generators 1 YEAR IN HOME /6-YEAR AT FACTORY PARTS & LABOR WARRANTY

The manufacturer will warranty all parts found to have a manufacturing defect on your PerfectSteam generator manufactured after March 1, 2009 and labor required to replace those parts for a period of 1-year on PerfectSteam generators at your home. At the end of your 1-year in-home warranty, there will still be a 5 year manufacturer “no questions asked” – factory warranty. The manufacturer will repair the specific failure on your PerfectSteam generator manufactured after March 1, 2009, at its factory for 6 full years. All expenses required to remove and send the unit to the factory, return and reinstall the unit is the responsibility of the owner.

WARRANTY EXCLUSIONS

Any discoloration of the steam head and control due to staining, scratching or use of harsh or abrasive cleaning chemicals; calcification build-up due to water conditions and/or improper maintenance; damage caused in the event of accident, neglect, misuse, vandalism, fire, lightning, power surge, earthquake, flood or any other peril or damage to structure or other acts of God.

TERMINATION

This warranty will be terminated by the manufacturer for the following reasons: Improper installation or use; installations not observing National/Local Plumbing and/or Electrical codes; residential unit used in a non-residential or commercial application; service to equipment by unauthorized personnel; installation that does not permit proper access for service; non-payment of repairs not covered under warranty; modification to any part of the unit; use of other than genuine manufacturer repair parts.

LIABILITY EXCLUSIONS

- 1.The manufacturer will not be liable in any way for any contingent liability or incidental or consequential damages resulting from the sale, delivery, installation or use of its products. Users are responsible for suitability of the products for their application. Damage resulting from improper specification or application or other operating conditions beyond the manufacturer’s control is not under warranty.
- 2.The manufacturer will exercise reasonable efforts in rendering service under this warranty, but shall not be liable for any damage arising out of delays; this warranty only covers the repair and/or replacement of PerfectSteam product as specified by the warranty.
- 3.This warranty gives you specific legal rights and you may also have other rights, which may vary, from state to state. Determination of rights under this warranty is in accordance with the laws of Texas. Any dispute under the warranty must be submitted and resolved by arbitration in Texas.
- 4.The manufacturer does not guarantee that a local service person will be available for in-home service. Unit may have to be removed and reinstalled at owner’s expense. It is the responsibility of the buyer to file a claim with the carrier/carriers for any product that has shipping damage to or from the manufacturer. An EVA (Evaluation Number) must be obtained from the factory and used on any correspondence or packages sent to the factory.

TECHNICAL AND WARRANTY SUPPORT ONLY:

1-800-585-7832

OWNERS NAME: _____ PHONE: (____) _____ E-MAIL: _____

ADDRESS: _____ CITY: _____ STATE: _____ ZIP: _____

SERIAL NO: _____ DATE CODE: _____ MODEL NO: _____

DATE OF PURCHASE: _____ DEALER/OUTLET: _____

INSTALLER NAME: _____ INSTALLER PHONE: (____) _____

INSTALLER ADDRESS: _____ CITY: _____ STATE: _____ ZIP: _____

SIGNATURE: _____ DATE INSTALLED: _____

