



iR PACKAGED DEDICATED HORIZONTAL HEAT PUMP



RHPBZR 13.4 SEER2
Nominal Sizes 2-5 Tons [7-17.6 kW]

Manufactured for
Mainline[®]
HVACmainline.com



"Proper sizing and installation of equipment is critical to achieve optimal performance. Ask your Contractor for details or visit www.energystar.gov."

Table of Contents

Unit Features & Benefits	3-6
Model Number Identification	7
General Data	8-9
General Data Notes	10
Gross Systems Performance Data	11-19
Indoor Airflow Performance.....	20
Electrical Data	21
Electric Heater Kits.....	22
Dimensional Data.....	23
Typical Installations	24
Limited Warranty	25



The RHPBZR series of Packaged Heat Pumps are designed to be the quickest to install, easiest to service, and most reliable units in the industry – while still maintaining an affordable price. This platform provides you with a full line of nominal capacities from 2 through 5 tons. AHRI-certified at 13.4 SEER2.

As with all units offered by Mainline, we started our design process with input from the customer. From fan grille to the base rails, Mainline has combined 30 years worth of package unit design experience with input from Dealers to meet the latest application requirements.

Starting at the bottom, the base rails (1) allow for separation between the unit base and the ground level, protecting the base from ground moisture and providing air circulation around the unit. Constructed from sturdy 18-gauge G-90 sheet metal, the base rails also allow for easier maneuverability during installation.

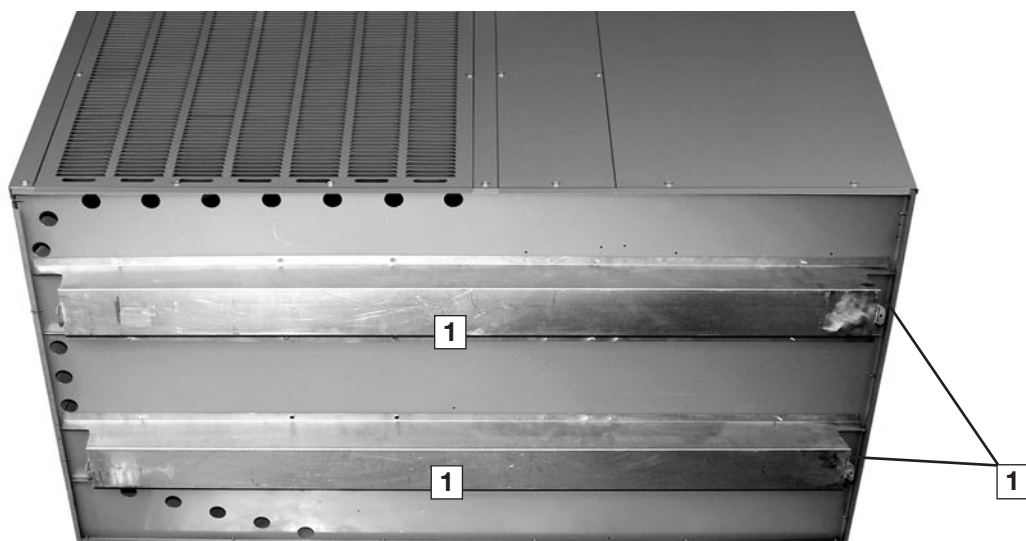

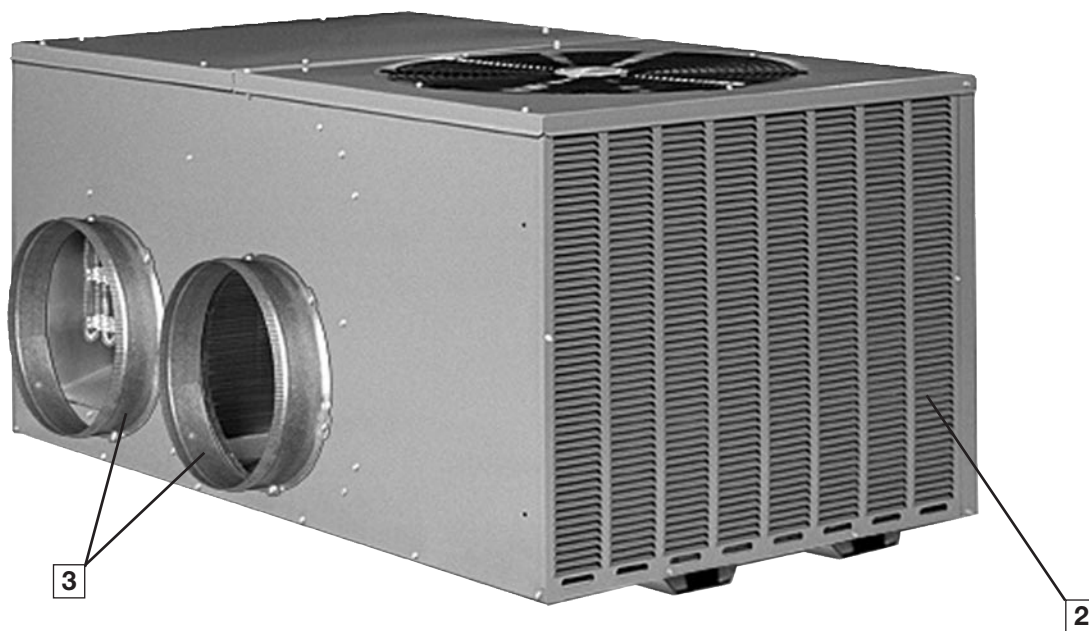

To provide flexibility in space-limited installations, the unit can be installed flush to the structure without blocking airflow over the outdoor coil or making any screws inaccessible for maintenance. Furthermore, the cabinet is a slim 33" wide. Full-louver coil protection ([2]) makes Mainline unique in the industry and also totally protects the outdoor coil from vandalism and weather extremes.

Two round 14" duct collar ([3]) are included with the unit, which makes attaching duct a snap. The collar is crimped around the leading edge, making it easier to install duct onto the collar. A metal bead around the circumference prevents the attached ducting from sliding off after installation.

Keeping service technicians in mind, Mainline takes pride providing easy access to internal components. The outdoor-section top cover ([4]) is easily removed to allow access to the scroll compressor ([5]), outdoor fan motor ([6]), and refrigerant tubing ([7]).

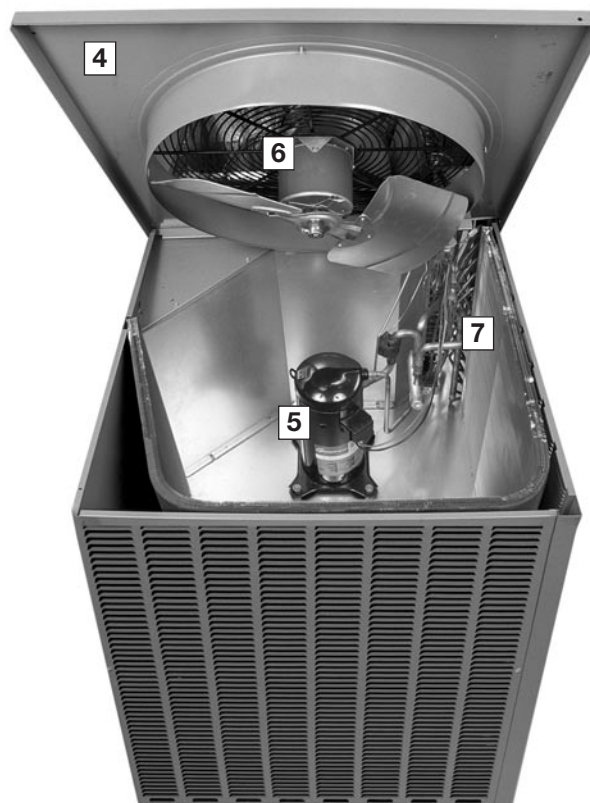

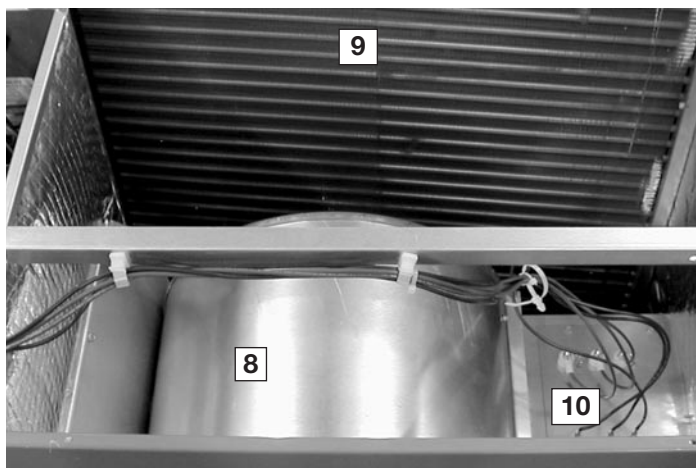

The indoor-section top cover also easily opens to access the removable blower housing and motor (**8**). This also gains total access to the indoor coil for cleaning and service (**9**).

The indoor motor and blower system will achieve nominal 400 CFM per ton up to a minimum of .8 inches of static pressure, which helps to eliminate customer dissatisfaction over poor air-flow brought about by high-static duct designs.

Optional electric heat (**10**) can be easily installed in the field, with either dual- or single-point power, and is designed to easily install into the unit. Electric heat can also be specified as factory installed.

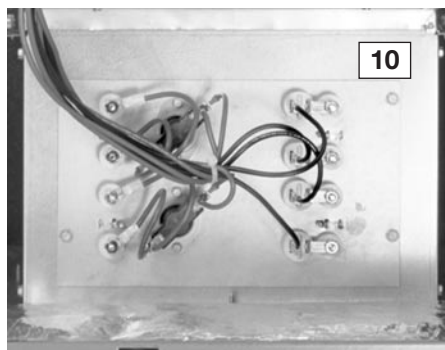

The controls are located in a large, easy-to-access control box (**11**), which provides plenty of space in which to troubleshoot. A demand defrost control (**12**) is used to manage the defrost cycle. The transformer (**13**) is protected by an in-line fuse, which protects the transformer during a low-voltage electrical short. The low-voltage (**14**) and high-voltage (**15**) wiring connections are easily accessed and have ample room around which to maneuver. Troubleshooting is further aided with number- and color-coded wiring, which corresponds with the large, easy-to-read wiring diagram located on the inside of the control box access panel.

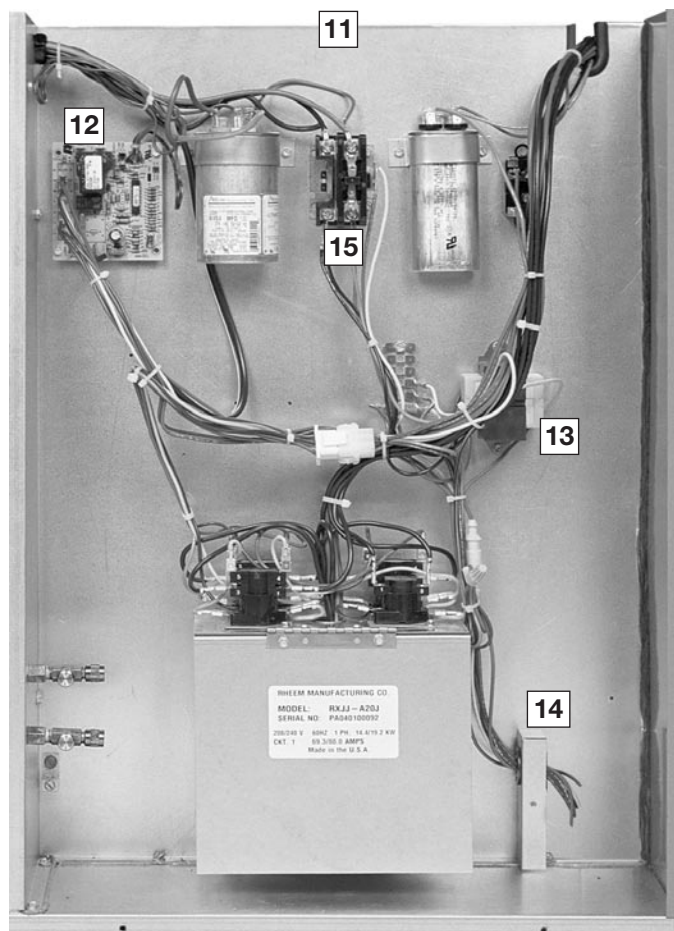

RHPBZR

High and low pressure can easily and accurately be measured using the two gauge ports (**16**) located inside the control box.

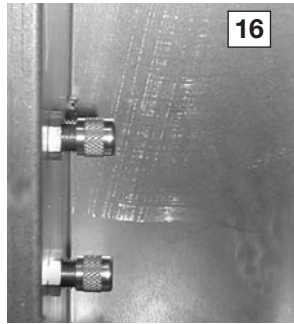

Foil-faced insulation is securely glued and captured to the cabinet. On the base of the unit, closed-cell insulation is used to prevent moisture from being absorbed and help reduce mold content to provide better indoor air quality.

Mainline uses 100% scroll compressor technology (**19**) on packaged platforms.

(Note: The RHPBZR uses a two stage scroll compressor).



A small side panel grants access to a removable, sloped drain pan (**17**), which helps to ensure indoor air quality (IAQ) throughout the life of the unit.

“Patent 7,430,877”



Low pressure control standard on all models (**20**).
High pressure control standard on -060 model.

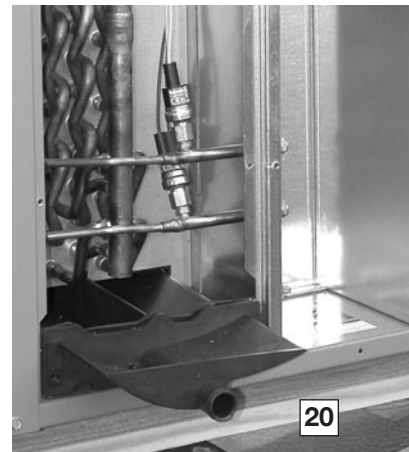

Heat Pumps

<u>R</u>	<u>HP</u>	<u>B</u>	<u>Z</u>	<u>R</u>	<u>024</u>	<u>A</u>	<u>J</u>	<u>T</u>	<u>00</u>	<u>0</u>	<u>N</u>	<u>A</u>
Brand	Product Category	Platform	Refrigerant	Tier	Capacity BTU/HR	Major Series	Voltage	Drive	Electric Heat	Electric Heat Configuration	Control	Minor Series
R - Mainline	HP - Heat Pump	B - ResiPack Dedicated Horizontal	Z - R-410A	R - Base Tier (13.4 SEER2)	024 - 24K BTUH [7.03 kW] 030 - 30K BTUH [8.79 kW] 036 - 36K BTUH [10.55 kW] 042 - 42K BTUH [12.31 kW] 048 - 48K BTUH [14.07 kW] 060 - 60K BTUH [17.58 kW]	A - 1st Design Series	J - 1ph, 208-230/60	T - Constant Torque	00 - No Electric Heat 10 - 10 kW Electric Heat 15 - 15 kW Electric Heat 20 - 20 kW Electric Heat	0 - No Electric Heat 1 - Electric Heat Factory Installed	N - Non-Comm.	A - 1st Design

[] Designates Metric Conversions

Available Models
RHPBZR024AJT000NA
RHPBZR024AJT101NA
RHPBZR030AJT000NA
RHPBZR030AJT101NA
RHPBZR036AJT000NA
RHPBZR036AJT101NA
RHPBZR042AJT000NA
RHPBZR042AJT151NA
RHPBZR048AJT000NA
RHPBZR048AJT151NA
RHPBZR060AJT000NA
RHPBZR060AJT201NA

Note: Bold represents 2-stage compressor models.

Further heater kits available to purchase for field installation.
Tinned evaporator coil options (AUA) also available.

NOMINAL SIZES 2-5 TONS [7-17.6 kW]

Model RHPBZR- Series	024AJT	030AJT	036AJT	042AJT
Cooling Performance¹				CONTINUED →
Gross Cooling Capacity Btu [kW]	24,000 [7.03]	29,000 [8.5]	36,200 [10.61]	41,000 [12.01]
EER2/SEER2 ²	10.6/13.4	10.6/13.4	10.6/13.4	10.6/13.4
Nominal CFM/AHRI Rated CFM [L/s]	800/800 [378/378]	1000/1000 [472/472]	1200/1200 [566/566]	1400/1400 [661/661]
AHRI Net Cooling Capacity Btu [kW]	23,600 [6.91]	28,200 [8.26]	35,400 [10.37]	40,000 [11.72]
Net Sensible Capacity Btu [kW]	19,080 [5.59]	23,450 [6.87]	27,870 [8.17]	30,770 [9.02]
Net Latent Capacity Btu [kW]	4,520 [1.32]	4,750 [1.39]	7,530 [2.21]	9,230 [2.7]
Net System Power [kW]	2.03	2.35	3.15	3.54
Heating Performance (Heat Pumps)				
High Temp. Btuh [kW] Rating	22,400 [6.56]	27,000 [7.91]	36,000 [10.55]	37,400 [10.96]
System Power KW / COP	1.94/3.42	2.24/3.58	3.16/3.44	3.66/3.32
Low Temp. Btuh [kW] Rating	12,600 [3.69]	15,200 [4.45]	20,800 [6.09]	21,800 [6.39]
System Power KW / COP	1.79/2.08	2.01/2.3	2.72/2.24	2.98/2.2
HSPF2 ³ (Btu/Watts-hr)	6.7	6.7	6.7	6.7
Compressor				
No./Type	1/Scroll	1/Scroll	1/Scroll	1/Scroll
Outdoor Sound Rating (dB)⁴	78	77	80	80
Outdoor Coil—Fin Type	Louvered	Louvered	Louvered	Louvered
Tube Type	Rifled	Rifled	Rifled	Rifled
Tube Size in. [mm] OD	0.375 [9.5]	0.375 [9.5]	0.375 [9.5]	0.375 [9.5]
Face Area sq. ft. [sq. m]	12.65 [1.18]	20.57 [1.91]	16.54 [1.54]	26.9 [2.5]
Rows / FPI [FPcm]	1 / 20 [8]	2 / 16 [6]	1 / 22 [9]	2 / 18 [7]
Refrigerant Control	TX Valves	TX Valves	TX Valves	TX Valves
Indoor Coil—Fin Type	Louvered	Louvered	Louvered	Louvered
Tube Type	Rifled	Rifled	Rifled	Rifled
Tube Size in. [mm] OD	0.375 [9.5]	0.375 [9.5]	0.375 [9.5]	0.375 [9.5]
Face Area sq. ft. [sq. m]	4.33 [0.4]	4.33 [0.4]	5.78 [0.54]	5.78 [0.54]
Rows / FPI [FPcm]	2 / 15 [6]	3 / 13 [5]	2 / 15 [6]	3 / 13 [5]
Refrigerant Control	TX Valves	TX Valves	TX Valves	TX Valves
Drain Connection No./Size in. [mm]	1/0.75 [19.05]	1/0.75 [19.05]	1/1 [25.4]	1/0.75 [19.05]
Outdoor Fan—Type	Propeller	Propeller	Propeller	Propeller
No. Used/Diameter in. [mm]	1/24 [609.6]	1/24 [609.6]	1/24 [609.6]	1/24 [609.6]
Drive Type/No. Speeds	Direct/1	Direct/1	Direct/1	Direct/1
CFM [L/s]	3200 [1510]	3200 [1510]	3300 [1557]	4000 [1888]
No. Motors/HP	1 at 1/3 HP	1 at 1/3 HP	1 at 1/3 HP	1 at 1/3 HP
Motor RPM	825	825	825	1075
Indoor Fan—Type	FC Centrifugal	FC Centrifugal	FC Centrifugal	FC Centrifugal
No. Used/Diameter in. [mm]	1/10x9 [254x229]	1/10x9 [254x229]	1/12x9 [305x229]	1/12x9 [305x229]
Drive Type	Direct	Direct	Direct	Direct
No. Speeds	Multiple	Multiple	Multiple	Multiple
No. Motors	1	1	1	1
Motor HP	1/2	1/2	3/4	3/4
Motor RPM	1050	1050	1050	1050
Motor Frame Size	48	48	48	48
Filter—Type	Field Supplied	Field Supplied	Field Supplied	Field Supplied
Furnished	No	No	No	No
(NO.) Size Recommended in. [mm x mm x mm]	(1)1x20x20 [25x508x508]	(1)1x20x20 [25x508x508]	(1)1x24x24 [25x610x610]	(1)1x24x24 [25x610x610]
Refrigerant Charge Oz. [g]	103.2 [2926]	155 [4394]	113 [3204]	202.4 [5738]
Weights				
Net Weight lbs. [kg]	302 [137]	329 [149]	350 [159]	400 [181]
Ship Weight lbs. [kg]	327 [148]	354 [161]	375 [170]	425 [193]

See Page 10 for Notes.

[] Designates Metric Conversions

NOMINAL SIZES 2-5 TONS [7-17.6 kW]

Model RHPBZR- Series	048AJT	060AJT
Cooling Performance¹		
Gross Cooling Capacity Btu [kW]	48,000 [14.06]	58,500 [17.14]
EER2/SEER2 ²	10.6/13.4	10.6/13.4
Nominal CFM/AHRI Rated CFM [L/s]	1600/1600 [755/755]	2000/1900 [944/897]
AHRI Net Cooling Capacity Btu [kW]	46,500 [13.62]	56,500 [16.55]
Net Sensible Capacity Btu [kW]	36,250 [10.62]	45,090 [13.21]
Net Latent Capacity Btu [kW]	10,250 [3]	11,410 [3.34]
Net System Power [kW]	4	5.09
Heating Performance (Heat Pumps)		
High Temp. Btuh [kW] Rating	46,500 [13.62]	57,500 [16.85]
System Power KW / COP	4.14/3.3	4.95/3
Low Temp. Btuh [kW] Rating	26,800 [7.85]	31,400 [9.2]
System Power KW / COP	3.62/2.1	4.26/2.16
HSPF2 ³ (Btu/Watts-hr)	6.7	6.7
Compressor		
No./Type	1/Scroll	1/Scroll
Outdoor Sound Rating (dB)⁴		
	77	80
Outdoor Coil—Fin Type		
Tube Type	Louvered	Louvered
Tube Type	Rifled	Rifled
Tube Size in. [mm] OD	0.375 [9.5]	0.375 [9.5]
Face Area sq. ft. [sq. m]	2690 [249.91]	32.39 [3.01]
Rows / FPI [FPcm]	2 / 18 [7]	2 / 18 [7]
Refrigerant Control	TX Valves	TX Valves
Indoor Coil—Fin Type		
Tube Type	Louvered	Louvered
Tube Type	Rifled	Rifled
Tube Size in. [mm] OD	0.375 [9.5]	0.375 [9.5]
Face Area sq. ft. [sq. m]	5.78 [0.54]	5.78 [0.54]
Rows / FPI [FPcm]	3 / 13 [5]	4 / 13 [5]
Refrigerant Control	TX Valves	TX Valves
Drain Connection No./Size in. [mm]	1/1 [25.4]	1/1 [25.4]
Outdoor Fan—Type		
	Propeller	Propeller
No. Used/Diameter in. [mm]	1/24 [609.6]	1/24 [609.6]
Drive Type/No. Speeds	Direct/1	Direct/1
CFM [L/s]	4000 [1888]	4000 [1888]
No. Motors/HP	1 at 1/3 HP	1 at 1/2 HP
Motor RPM	1075	1075
Indoor Fan—Type		
	FC Centrifugal	FC Centrifugal
No. Used/Diameter in. [mm]	1/12x9 [305x229]	1/12x9 [305x229]
Drive Type	Direct	Direct
No. Speeds	Multiple	Multiple
No. Motors	1	1
Motor HP	3/4	1
Motor RPM	1050	1050
Motor Frame Size	48	48
Filter—Type		
Furnished	Field Supplied	Field Supplied
	No	No
(NO.) Size Recommended in. [mm x mm x mm]	(1)1x24x24 [25x610x610]	(1)1x24x24 [25x610x610]
Refrigerant Charge Oz. [g]		
	175 [4961]	212 [6010]
Weights		
Net Weight lbs. [kg]	397 [180]	429 [195]
Ship Weight lbs. [kg]	422 [191]	454 [206]

See Page 10 for Notes.

[] Designates Metric Conversions

NOTES:

1. Cooling Performance is rated at 95°F ambient, 80°F entering dry bulb, 67°F entering wet bulb. Gross capacity does not include the effect of fan motor heat. ARI capacity is net and includes the effect of fan motor heat. Units are suitable for operation to $\pm 20\%$ of nominal cfm. Units are certified in accordance with the Unitary Air Conditioner Equipment certification program, which is based on ARI Standard 210/240 or 360.
2. EER2 and/or SEER2 are rated at ARI conditions and in accordance with DOE test procedures for 1-Phase models. EER and/or SEER are rated at ARI conditions and in accordance with DOE test procedures for 3-Phase models.
3. HSPF2 is rated at ARI conditions and in accordance with DOE test procedures for 1-Phase models. HSPF is rated at ARI conditions and in accordance with DOE test procedures for 3-Phase models.
4. Outdoor Sound Rating shown is tested in accordance with ARI Standard 270.

GROSS SYSTEMS COOLING PERFORMANCE DATA – RHPBZR024AJT000NA

ENTERING INDOOR AIR @ 80°F [26.7°C] dbE ①											
wbE		71°F [21.7°C]			67°F [19.4°C]			63°F [17.2°C]			
CFM [L/s]		900 [425]	800 [378]	650 [307]	900 [425]	800 [378]	650 [307]	900 [425]	800 [378]	650 [307]	
DR ①		.05	.09	.12	.05	.09	.12	.05	.09	.12	
OUTDOOR DRY BULB TEMPERATURE °F [°C]	75 [23.9]	Total BTUH [kW]	30.0 [8.8]	29.4 [8.6]	28.4 [8.3]	28.1 [8.2]	27.5 [8.1]	26.6 [7.8]	26.8 [7.9]	26.2 [7.7]	25.3 [7.4]
		Sens BTUH [kW]	17.5 [5.1]	16.5 [4.8]	15.1 [4.4]	21.0 [6.2]	19.9 [5.8]	18.1 [5.3]	24.4 [7.2]	23.1 [6.8]	21.1 [6.2]
		Power	1.7	1.7	1.6	1.7	1.7	1.6	1.7	1.7	1.6
	80 [26.7]	Total BTUH [kW]	29.2 [8.6]	28.5 [8.4]	27.6 [8.1]	27.3 [8.0]	26.7 [7.8]	25.8 [7.6]	25.9 [7.6]	25.4 [7.4]	24.5 [7.2]
		Sens BTUH [kW]	17.2 [5.0]	16.2 [4.7]	14.8 [4.3]	20.7 [6.1]	19.6 [5.7]	17.9 [5.2]	24.1 [7.1]	22.8 [6.7]	20.8 [6.1]
		Power	1.8	1.7	1.7	1.8	1.7	1.7	1.8	1.7	1.7
	85 [29.4]	Total BTUH [kW]	28.3 [8.3]	27.6 [8.1]	26.7 [7.8]	26.3 [7.7]	25.8 [7.6]	24.9 [7.3]	25.0 [7.3]	24.5 [7.2]	23.6 [6.9]
		Sens BTUH [kW]	16.8 [4.9]	15.9 [4.7]	14.5 [4.2]	20.4 [6.0]	19.2 [5.6]	17.6 [5.2]	23.8 [7.0]	22.5 [6.6]	20.5 [6.0]
		Power	1.9	1.8	1.8	1.9	1.8	1.8	1.9	1.8	1.8
	90 [32.2]	Total BTUH [kW]	27.3 [8.0]	26.7 [7.8]	25.8 [7.6]	25.4 [7.4]	24.8 [7.3]	24.0 [7.0]	24.0 [7.0]	23.5 [6.9]	22.7 [6.7]
		Sens BTUH [kW]	16.4 [4.8]	15.5 [4.5]	14.2 [4.2]	20.0 [5.9]	18.9 [5.5]	17.2 [5.0]	23.4 [6.9]	22.1 [6.5]	20.2 [5.9]
		Power	2.0	1.9	1.9	2.0	1.9	1.9	2.0	1.9	1.9
95 [35]	Total BTUH [kW]	26.2 [7.7]	25.7 [7.5]	24.8 [7.3]	24.3 [7.1]	23.8 [7.0]	23.0 [6.7]	23.0 [6.7]	22.5 [6.6]	21.7 [6.4]	
	Sens BTUH [kW]	16.0 [4.7]	15.1 [4.4]	13.8 [4.0]	19.6 [5.7]	18.5 [5.4]	16.9 [5.0]	23.0 [6.7]	21.7 [6.4]	19.8 [5.8]	
	Power	2.1	2.0	2.0	2.1	2.0	2.0	2.1	2.0	2.0	
100 [37.8]	Total BTUH [kW]	25.1 [7.4]	24.6 [7.2]	23.7 [6.9]	23.2 [6.8]	22.7 [6.7]	21.9 [6.4]	21.9 [6.4]	21.4 [6.3]	20.7 [6.1]	
	Sens BTUH [kW]	15.6 [4.6]	14.7 [4.3]	13.4 [3.9]	19.1 [5.6]	18.0 [5.3]	16.5 [4.8]	21.9 [6.4]	21.3 [6.2]	19.4 [5.7]	
	Power	2.2	2.2	2.1	2.2	2.2	2.1	2.2	2.2	2.1	
105 [40.6]	Total BTUH [kW]	24.0 [7.0]	23.5 [6.9]	22.7 [6.7]	22.1 [6.5]	21.6 [6.3]	20.8 [6.1]	20.7 [6.1]	20.3 [5.9]	19.6 [5.7]	
	Sens BTUH [kW]	15.1 [4.4]	14.2 [4.2]	13.0 [3.8]	18.6 [5.5]	17.6 [5.2]	16.0 [4.7]	20.7 [6.1]	20.3 [5.9]	19.0 [5.6]	
	Power	2.3	2.3	2.2	2.3	2.3	2.2	2.3	2.3	2.2	
110 [43.3]	Total BTUH [kW]	22.8 [6.7]	22.3 [6.5]	21.5 [6.3]	20.9 [6.1]	20.4 [6.0]	19.7 [5.8]	19.5 [5.7]	19.1 [5.6]	18.4 [5.4]	
	Sens BTUH [kW]	14.5 [4.2]	13.7 [4.0]	12.5 [3.7]	18.1 [5.3]	17.1 [5.0]	15.6 [4.6]	19.5 [5.7]	19.1 [5.6]	18.4 [5.4]	
	Power	2.4	2.4	2.4	2.4	2.4	2.4	2.4	2.4	2.4	
115 [46.1]	Total BTUH [kW]	21.5 [6.3]	21.0 [6.2]	20.3 [5.9]	19.6 [5.7]	19.1 [5.6]	18.5 [5.4]	18.2 [5.3]	17.8 [5.2]	17.2 [5.0]	
	Sens BTUH [kW]	14.0 [4.1]	13.2 [3.9]	12.1 [3.5]	17.5 [5.1]	16.6 [4.9]	15.1 [4.4]	18.2 [5.3]	17.8 [5.2]	17.2 [5.0]	
	Power	2.6	2.5	2.5	2.6	2.5	2.5	2.6	2.5	2.5	
120 [48.9]	Total BTUH [kW]	20.2 [5.9]	19.7 [5.8]	19.0 [5.6]	18.2 [5.3]	17.8 [5.2]	17.2 [5.0]	16.9 [5.0]	16.5 [4.8]	16.0 [4.7]	
	Sens BTUH [kW]	13.4 [3.9]	12.7 [3.7]	11.6 [3.4]	1.07 [5.0]	16.0 [4.7]	14.6 [4.3]	16.9 [5.0]	16.5 [4.8]	16.0 [4.7]	
	Power	2.7	2.7	2.6	2.7	2.7	2.6	2.7	2.7	2.6	
125 [51.7]	Total BTUH [kW]	18.8 [5.5]	18.4 [5.4]	17.7 [5.2]	16.9 [5.0]	16.5 [4.8]	15.9 [4.7]	15.5 [4.5]	15.2 [4.5]	14.7 [4.3]	
	Sens BTUH [kW]	12.8 [3.8]	12.1 [3.5]	11.0 [3.2]	16.3 [4.8]	15.4 [4.5]	14.1 [4.1]	15.5 [4.5]	15.2 [4.5]	14.7 [4.3]	
	Power	2.9	2.8	2.8	2.9	2.8	2.8	2.9	2.8	2.8	

DR —Depression ratio
dbE —Entering air dry bulb
wbE—Entering air wet bulb

Total —Total capacity x 1000 BTUH
Sens —Sensible capacity x 1000 BTUH
Power —KW input

NOTES: ① When the entering air dry bulb is other than 80°F [27°C], adjust the sensible capacity from the table by adding [1.10 x CFM x (1 – DR) x (dbE – 80)].

[] Designates Metric Conversions

GROSS SYSTEMS COOLING PERFORMANCE DATA—RHPBZR030AJT000NA

ENTERING INDOOR AIR @ 80°F [26.7°C] dbE ①											
wbE		71°F [21.7°C]			67°F [19.4°C]			63°F [17.2°C]			
CFM [L/s]		1075 [507]	1000 [472]	775 [366]	1075 [507]	1000 [472]	775 [366]	1075 [507]	1000 [472]	775 [366]	
DR ①		.05	.09	.12	.05	.09	.12	.05	.09	.12	
OUTDOOR DRY BULB TEMPERATURE °F [°C]	75 [23.9]	Total BTUH [kW] Sens BTUH [kW] Power	32.5 [9.5] 19.7 [5.8] 1.9	32.1 [9.4] 19.0 [5.6] 1.9	30.8 [9.0] 17.0 [5.0] 1.9	31.1 [9.1] 24.4 [7.2] 1.9	30.7 [9.0] 23.5 [6.9] 1.9	29.4 [8.6] 21.1 [6.2] 1.9	30.2 [8.9] 28.3 [8.3] 1.9	29.8 [8.7] 27.3 [8.0] 1.9	28.5 [8.4] 24.5 [7.2] 1.9
	80 [26.7]	Total BTUH [kW] Sens BTUH [kW] Power	32.2 [9.4] 19.9 [5.8] 2.0	31.7 [9.3] 19.2 [5.6] 2.0	30.4 [8.9] 17.2 [5.0] 2.0	30.8 [9.0] 24.6 [7.2] 2.0	30.3 [8.9] 23.7 [6.9] 2.0	29.1 [8.5] 21.2 [6.2] 2.0	29.8 [8.7] 28.5 [8.4] 2.0	29.4 [8.6] 27.5 [8.1] 2.0	28.2 [8.3] 24.6 [7.2] 2.0
	85 [29.4]	Total BTUH [kW] Sens BTUH [kW] Power	31.7 [9.3] 20.0 [5.9] 2.2	31.2 [9.1] 19.3 [5.7] 2.1	30.0 [8.8] 17.3 [5.1] 2.1	30.3 [8.9] 24.6 [7.2] 2.1	29.9 [8.8] 23.8 [7.0] 2.1	28.6 [8.4] 21.3 [6.2] 2.1	29.3 [8.6] 28.6 [8.4] 2.1	28.9 [8.5] 27.6 [8.1] 2.1	27.7 [8.1] 24.7 [7.2] 2.1
	90 [32.2]	Total BTUH [kW] Sens BTUH [kW] Power	31.0 [9.1] 19.9 [5.8] 2.3	30.6 [9.0] 19.2 [5.6] 2.3	29.4 [8.6] 17.2 [5.0] 2.2	29.6 [8.7] 24.6 [7.2] 2.3	29.2 [8.6] 23.8 [7.0] 2.2	28.0 [8.2] 21.3 [6.2] 2.2	28.7 [8.4] 28.5 [8.4] 2.2	28.3 [8.3] 27.6 [8.1] 2.2	27.1 [7.9] 24.7 [7.2] 2.2
	95 [35]	Total BTUH [kW] Sens BTUH [kW] Power	30.2 [8.9] 19.7 [5.8] 2.4	29.8 [8.7] 19.1 [5.6] 2.4	28.6 [8.4] 17.1 [5.0] 2.3	28.8 [8.4] 24.4 [7.2] 2.4	28.5 [8.4] 23.6 [6.9] 2.4	27.3 [8.0] 21.1 [6.2] 2.3	27.9 [8.2] 27.9 [8.2] 2.4	27.5 [8.1] 27.4 [8.0] 2.3	26.4 [7.7] 24.5 [7.2] 2.3
	100 [37.8]	Total BTUH [kW] Sens BTUH [kW] Power	29.3 [8.6] 19.4 [5.7] 2.5	28.9 [8.5] 18.8 [5.5] 2.5	27.8 [8.1] 16.8 [4.9] 2.5	27.9 [8.2] 24.1 [7.1] 2.5	27.6 [8.1] 23.3 [6.8] 2.5	26.4 [7.7] 20.9 [6.1] 2.4	27.0 [7.9] 27.0 [7.9] 2.5	26.6 [7.8] 26.6 [7.8] 2.5	25.5 [7.5] 24.3 [7.1] 2.4
	105 [40.6]	Total BTUH [kW] Sens BTUH [kW] Power	28.3 [8.3] 19.0 [5.6] 2.7	27.9 [8.2] 18.4 [5.4] 2.6	26.7 [7.8] 16.5 [4.8] 2.6	26.9 [7.9] 23.7 [6.9] 2.6	26.5 [7.8] 22.9 [6.7] 2.6	25.4 [7.4] 20.5 [6.0] 2.6	25.9 [7.6] 25.9 [7.6] 2.6	25.6 [7.5] 25.6 [7.5] 2.6	24.5 [7.2] 23.9 [7.0] 2.6
	110 [43.3]	Total BTUH [kW] Sens BTUH [kW] Power	27.1 [7.9] 18.5 [5.4] 2.8	26.7 [7.8] 17.9 [5.2] 2.8	25.6 [7.5] 16.0 [4.7] 2.7	25.7 [7.5] 23.2 [6.8] 2.8	25.3 [7.4] 22.4 [6.6] 2.8	24.3 [7.1] 20.0 [5.9] 2.7	24.7 [7.2] 24.7 [7.2] 2.8	24.4 [7.2] 24.4 [7.2] 2.7	23.4 [6.9] 23.4 [6.9] 2.7
	115 [46.1]	Total BTUH [kW] Sens BTUH [kW] Power	25.7 [7.5] 17.8 [5.2] 2.9	25.4 [7.4] 17.2 [5.0] 2.9	24.3 [7.1] 15.4 [4.5] 2.9	24.3 [7.1] 22.5 [6.6] 2.9	24.0 [7.0] 21.7 [6.4] 2.9	23.0 [6.7] 19.4 [5.7] 2.8	23.4 [6.9] 23.4 [6.9] 2.9	23.1 [6.8] 23.1 [6.8] 2.9	22.1 [6.5] 22.1 [6.5] 2.8
	120 [48.9]	Total BTUH [kW] Sens BTUH [kW] Power	24.2 [7.1] 17.0 [5.0] 3.1	23.9 [7.0] 16.4 [4.8] 3.1	22.9 [6.7] 14.7 [4.3] 3.0	22.8 [6.7] 21.7 [6.4] 3.1	22.5 [6.6] 21.0 [6.2] 3.0	21.6 [6.3] 18.8 [5.5] 3.0	21.9 [6.4] 21.9 [6.4] 3.1	21.6 [6.3] 21.6 [6.3] 3.0	20.7 [6.1] 20.7 [6.1] 3.0
	125 [51.7]	Total BTUH [kW] Sens BTUH [kW] Power	22.6 [6.6] 16.1 [4.7] 3.2	22.3 [6.5] 15.5 [4.5] 3.2	21.4 [6.3] 13.9 [4.1] 3.2	21.2 [6.2] 20.8 [6.1] 3.2	20.9 [6.1] 20.1 [5.9] 3.2	20.1 [5.9] 18.0 [5.3] 3.1	20.3 [5.9] 20.3 [5.9] 3.2	20.0 [5.9] 20.0 [5.9] 3.2	19.2 [5.6] 19.2 [5.6] 3.1

DR —Depression ratio
dbE —Entering air dry bulb
wbE—Entering air wet bulb

Total —Total capacity x 1000 BTUH
Sens —Sensible capacity x 1000 BTUH
Power—KW input

NOTES: ① When the entering air dry bulb is other than 80°F [27°C], adjust the sensible capacity from the table by adding $[1.10 \times \text{CFM} \times (1 - \text{DR}) \times (\text{dbE} - 80)]$.

[] Designates Metric Conversions

GROSS SYSTEMS COOLING PERFORMANCE DATA – RHPBZR036AJT00NA

wbE		ENTERING INDOOR AIR @ 80°F [26.7°C] dbE ①									
		71°F [21.7°C]			67°F [19.4°C]			63°F [17.2°C]			
CFM [L/s]		1325 [625]	1200 [566]	975 [460]	1325 [625]	1200 [566]	975 [460]	1325 [625]	1200 [566]	975 [460]	
DR ①		.05	.09	.12	.05	.09	.12	.05	.09	.12	
OUTDOOR DRY BULB TEMPERATURE °F [°C]	75 [23.9]	Total BTUH [kW] Sens BTUH [kW] Power	43.4 [12.7] 26.4 [7.7] 2.6	42.6 [12.5] 25.2 [7.4] 2.6	41.1 [12.0] 23.0 [6.7] 2.5	41.2 [12.1] 31.6 [9.3] 2.6	40.4 [11.8] 30.2 [8.9] 2.5	39.1 [11.5] 27.5 [8.1] 2.5	39.0 [11.4] 36.2 [10.6] 2.5	38.3 [11.2] 34.5 [10.1] 2.5	37.0 [10.8] 31.5 [9.2] 2.5
	80 [26.7]	Total BTUH [kW] Sens BTUH [kW] Power	42.1 [12.3] 25.6 [7.5] 2.7	41.3 [12.1] 24.4 [7.2] 2.7	39.9 [11.7] 22.2 [6.5] 2.7	40v [11.7] 30.8 [9.0] 2.7	39.2 [11.5] 29.4 [8.6] 2.7	37.9 [11.1] 26.8 [7.9] 2.6	37.8 [11.1] 35.3 [10.3] 2.7	37.1 [10.9] 33.7 [9.9] 2.7	35.8 [10.5] 30.7 [9.0] 2.6
	85 [29.4]	Total BTUH [kW] Sens BTUH [kW] Power	40.9 [12.0] 24.8 [7.3] 2.9	40.1 [11.8] 23.7 [6.9] 2.9	38.8 [11.4] 21.6 [6.3] 2.8	38.7 [11.3] 30.0 [8.8] 2.9	38.0 [11.1] 28.6 [8.4] 2.8	36.7 [10.8] 26.1 [7.6] 2.8	36.6 [10.7] 34.6 [10.1] 2.9	35.9 [10.5] 33.0 [9.7] 2.8	34.7 [10.2] 30.1 [8.8] 2.8
	90 [32.2]	Total BTUH [kW] Sens BTUH [kW] Power	39.6 [11.6] 24.1 [7.1] 3.1	38.9 [11.4] 23.0 [6.7] 3.0	37.6 [11.0] 21.0 [6.2] 3.0	37.5 [11.0] 29.3 [8.6] 3.0	36.8 [10.8] 28.0 [8.2] 3.0	35.5 [10.4] 25.5 [7.5] 3.0	35.3 [10.3] 33.9 [9.9] 3.0	34.7 [10.2] 32.3 [9.5] 3.0	33.5 [9.8] 29.5 [8.6] 2.9
	95 [35]	Total BTUH [kW] Sens BTUH [kW] Power	38.4 [11.3] 23.5 [6.9] 3.2	37.7 [11.0] 22.4 [6.6] 3.2	36.4 [10.7] 20.5 [6.0] 3.1	36.2 [10.6] 28.7 [8.4] 3.2	35.6 [10.4] 27.4 [8.0] 3.2	34.4 [10.1] 25.0 [7.3] 3.1	34.1 [10.0] 33.3 [9.8] 3.2	33.4 [9.8] 31.7 [9.3] 3.2	32.3 [9.5] 29.0 [8.5] 3.1
	100 [37.8]	Total BTUH [kW] Sens BTUH [kW] Power	37.2 [10.9] 23.0 [6.7] 3.4	36.5 [10.7] 21.9 [6.4] 3.4	35.2 [10.3] 20.0 [5.9] 3.3	35.0 [10.3] 28.2 [8.3] 3.4	34.3 [10.1] 26.9 [7.9] 3.4	33.2 [9.7] 24.6 [7.2] 3.3	32.8 [9.6] 32.8 [9.6] 3.4	32.2 [9.4] 31.2 [9.1] 3.4	31.1 [9.1] 28.5 [8.4] 3.3
	105 [40.6]	Total BTUH [kW] Sens BTUH [kW] Power	35.9 [10.5] 22.6 [6.6] 3.6	35.3 [10.3] 21.5 [6.3] 3.6	34.1 [10.0] 19.6 [5.7] 3.5	33.8 [9.9] 27.8 [8.1] 3.6	33.1 [9.7] 26.5 [7.8] 3.6	32.0 [9.4] 24.2 [7.1] 3.5	31.6 [9.3] 31.6 [9.3] 3.6	31.0 [9.1] 30.8 [9.0] 3.5	29.9 [8.8] 28.1 [8.2] 3.5
	110 [43.3]	Total BTUH [kW] Sens BTUH [kW] Power	34.7 [10.2] 22.2 [6.5] 3.8	34.0 [10.0] 21.2 [6.2] 3.8	32.9 [9.6] 19.3 [5.7] 3.7	32.5 [9.5] 27.4 [8.0] 3.8	31.9 [9.3] 26.2 [7.7] 3.8	30.8 [9.0] 23.9 [7.0] 3.7	30.3 [8.9] 30.3 [8.9] 3.8	29.8 [8.7] 29.8 [8.7] 3.7	28.8 [8.4] 27.8 [8.1] 3.7
	115 [46.1]	Total BTUH [kW] Sens BTUH [kW] Power	33.4 [9.8] 21.9 [6.4] 4.0	32.8 [9.6] 20.9 [6.1] 4.0	31.7 [9.3] 19.1 [5.6] 3.9	31.3 [9.2] 27.2 [8.0] 4.0	30.7 [9.0] 25.9 [7.6] 4.0	29.6 [8.7] 23.6 [6.9] 3.9	29.1 [8.5] 29.1 [8.5] 4.0	28.6 [8.4] 28.6 [8.4] 4.0	27.6 [8.1] 27.6 [8.1] 3.9
	120 [48.9]	Total BTUH [kW] Sens BTUH [kW] Power	32.2 [9.4] 21.8 [6.4] 4.2	31.6 [9.3] 20.7 [6.1] 4.2	30.5 [8.9] 18.9 [5.5] 4.1	30.0 [8.8] 27.0 [7.9] 4.2	29.5 [8.6] 25.7 [7.5] 4.2	28.5 [8.4] 23.5 [6.9] 4.1	27.9 [8.2] 27.9 [8.2] 4.2	27.3 [8.0] 27.3 [8.0] 4.2	26.4 [7.7] 26.4 [7.7] 4.1
125 [51.7]	Total BTUH [kW] Sens BTUH [kW] Power	31.0 [9.1] 21.7 [6.4] 4.5	30.4 [8.9] 20.6 [6.0] 4.4	29.4 [8.6] 18.8 [5.5] 4.3	28.8 [8.4] 26.9 [7.9] 4.4	28.3 [8.3] 25.6 [7.5] 4.4	27.3 [8.0] 23.4 [6.9] 4.3	26.6 [7.8] 26.6 [7.8] 4.4	26.1 [7.6] 26.1 [7.6] 4.4	25.2 [7.4] 25.2 [7.4] 4.3	

DR —Depression ratio
dbE —Entering air dry bulb
wbE—Entering air wet bulb

Total —Total capacity x 1000 BTUH
Sens —Sensible capacity x 1000 BTUH
Power —KW input

NOTES: ① When the entering air dry bulb is other than 80°F [27°C], adjust the sensible capacity from the table by adding [1.10 x CFM x (1 – DR) x (dbE – 80)].

[] Designates Metric Conversions

GROSS SYSTEMS COOLING PERFORMANCE DATA—RHPBZR042AJT000NA

		ENTERING INDOOR AIR @ 80°F [26.7°C] dbE ①									
wbE		71°F [21.7°C]			67°F [19.4°C]			63°F [17.2°C]			
CFM [L/s]		1575 [743]	1400 [661]	1125 [531]	1575 [743]	1400 [661]	1125 [531]	1575 [743]	1400 [661]	1125 [531]	
DR ①		.05	.09	.12	.05	.09	.12	.05	.09	.12	
OUTDOOR DRY BULB TEMPERATURE °F [°C]	75 [23.9]	Total BTUH [kW] Sens BTUH [kW] Power	52.8 [15.5] 32.6 [9.6] 3.0	51.6 [15.1] 30.8 [9.0] 2.9	49.8 [14.6] 28.0 [8.2] 2.9	49.8 [14.6] 38.3 [11.2] 2.9	48.7 [14.3] 36.2 [10.6] 2.9	47.0 [13.8] 32.9 [9.6] 2.8	46.8 [13.7] 41.0 [12.0] 2.9	45.8 [13.4] 38.8 [11.4] 2.9	44.1 [12.9] 35.2 [10.3] 2.8
	80 [26.7]	Total BTUH [kW] Sens BTUH [kW] Power	51.0 [14.9] 31.4 [9.2] 3.1	49.9 [14.6] 29.6 [8.7] 3.1	48.1 [14.1] 26.9 [7.9] 3.0	48.0 [14.1] 37.1 [10.9] 3.1	46.9 [13.7] 35.0 [10.3] 3.0	45.3 [13.3] 31.8 [9.3] 3.0	45.0 [13.2] 39.8 [11.7] 3.0	44.0 [12.9] 37.6 [11.0] 3.0	42.4 [12.4] 34.1 [10.0] 3.0
	85 [29.4]	Total BTUH [kW] Sens BTUH [kW] Power	49.2 [14.4] 30.3 [8.9] 3.3	48.1 [14.1] 28.6 [8.4] 3.2	46.4 [13.6] 26.0 [7.6] 3.2	46.2 [13.5] 35.9 [10.5] 3.2	45.2 [13.2] 34.0 [10.0] 3.2	43.6 [12.8] 30.9 [9.1] 3.1	43.2 [12.7] 38.7 [11.3] 3.2	42.3 [12.4] 36.5 [10.7] 3.2	40.7 [11.9] 33.2 [9.7] 3.1
	90 [32.2]	Total BTUH [kW] Sens BTUH [kW] Power	47.4 [13.9] 29.3 [8.6] 3.4	46.4 [13.6] 27.6 [8.1] 3.4	44.7 [13.1] 25.1 [7.4] 3.3	44.4 [13.0] 35.0 [10.3] 3.4	43.4 [12.7] 33.0 [9.7] 3.4	41.9 [12.3] 30.0 [8.8] 3.3	41.4 [12.1] 37.7 [11.0] 3.4	40.5 [11.9] 35.6 [10.4] 3.3	39.1 [11.5] 32.3 [9.5] 3.3
	95 [35]	Total BTUH [kW] Sens BTUH [kW] Power	45.7 [13.4] 28.4 [8.3] 3.6	44.6 [13.1] 26.8 [7.9] 3.5	43.0 [12.6] 24.4 [7.2] 3.5	42.6 [12.5] 34.1 [10.0] 3.6	41.7 [12.2] 32.2 [9.4] 3.5	40.2 [11.8] 29.3 [8.6] 3.5	39.6 [11.6] 36.8 [10.8] 3.5	38.8 [11.4] 34.8 [10.2] 3.5	37.4 [11.0] 31.6 [9.3] 3.4
	100 [37.8]	Total BTUH [kW] Sens BTUH [kW] Power	43.9 [12.9] 27.6 [8.1] 3.8	42.9 [12.6] 26.1 [7.6] 3.7	41.4 [12.1] 23.7 [6.9] 3.7	40.9 [12.0] 33.3 [9.8] 3.7	39.9 [11.7] 31.5 [9.2] 3.7	38.5 [11.3] 28.6 [8.4] 3.6	37.8 [11.1] 36.0 [10.6] 3.7	37.0 [10.8] 34.1 [10.0] 3.7	35.7 [10.5] 30.9 [9.1] 3.6
	105 [40.6]	Total BTUH [kW] Sens BTUH [kW] Power	42.1 [12.3] 27.0 [7.9] 3.9	41.1 [12.0] 25.5 [7.5] 3.9	39.7 [11.6] 23.2 [6.8] 3.8	39.1 [11.5] 32.7 [9.6] 3.9	38.2 [11.2] 30.9 [9.1] 3.9	36.8 [10.8] 28.1 [8.2] 3.8	36.1 [10.6] 35.4 [10.4] 3.9	35.3 [10.3] 33.5 [9.8] 3.8	34.0 [10.0] 30.4 [8.9] 3.8
	110 [43.3]	Total BTUH [kW] Sens BTUH [kW] Power	40.3 [11.8] 26.5 [7.8] 4.1	39.4 [11.5] 25.0 [7.3] 4.1	38.0 [11.1] 22.7 [6.7] 4.0	37.3 [10.9] 32.2 [9.4] 4.1	36.4 [10.7] 30.4 [8.9] 4.0	35.1 [10.3] 27.6 [8.1] 4.0	34.3 [10.1] 34.3 [10.1] 4.1	33.5 [9.8] 33.0 [9.7] 4.0	32.3 [9.5] 30.0 [8.8] 3.9
	115 [46.1]	Total BTUH [kW] Sens BTUH [kW] Power	38.5 [11.3] 26.1 [7.6] 4.3	37.6 [11.0] 24.7 [7.2] 4.3	36.3 [10.6] 22.4 [6.6] 4.2	35.5 [10.4] 31.8 [9.3] 4.3	34.7 [10.2] 30.1 [8.8] 4.2	33.5 [9.8] 27.3 [8.0] 4.2	32.5 [9.5] 32.5 [9.5] 4.2	31.8 [9.3] 31.8 [9.3] 4.2	30.6 [9.0] 29.6 [8.7] 4.1
	120 [48.9]	Total BTUH [kW] Sens BTUH [kW] Power	36.7 [10.8] 25.8 [7.6] 4.5	35.9 [10.5] 24.4 [7.2] 4.5	34.6 [10.1] 22.2 [6.5] 4.4	33.7 [9.9] 31.5 [9.2] 4.5	33.0 [9.7] 29.8 [8.7] 4.4	31.8 [9.3] 27.1 [7.9] 4.3	30.7 [9.0] 30.7 [9.0] 4.4	30.0 [8.8] 30.0 [8.8] 4.4	28.9 [8.5] 28.9 [8.5] 4.3
125 [51.7]	Total BTUH [kW] Sens BTUH [kW] Power	34.9 [10.2] 25.7 [7.5] 4.7	34.1 [10.0] 24.3 [7.1] 4.7	32.9 [9.6] 22.1 [6.5] 4.6	31.9 [9.3] 31.4 [9.2] 4.7	31.2 [9.1] 29.7 [8.7] 4.6	30.1 [8.8] 26.9 [7.9] 4.5	28.9 [8.5] 28.9 [8.5] 4.6	28.3 [8.3] 28.3 [8.3] 4.6	27.2 [8.0] 27.2 [8.0] 4.5	

DR —Depression ratio
dbE —Entering air dry bulb
wbE—Entering air wet bulb

Total —Total capacity x 1000 BTUH
Sens —Sensible capacity x 1000 BTUH
Power —kW input

NOTES: ① When the entering air dry bulb is other than 80°F [27°C], adjust the sensible capacity from the table by adding $[1.10 \times \text{CFM} \times (1 - \text{DR}) \times (\text{dbE} - 80)]$.

[] Designates Metric Conversions

GROSS SYSTEMS COOLING PERFORMANCE DATA – RHPBZR048AJT00NA

		ENTERING INDOOR AIR @ 80°F [26.7°C] dbE ①									
		71°F [21.7°C]			67°F [19.4°C]			63°F [17.2°C]			
wbE		1775 [838]	1600 [755]	1275 [602]	1775 [838]	1600 [755]	1275 [602]	1775 [838]	1600 [755]	1275 [602]	
CFM [L/s]		1775 [838]	1600 [755]	1275 [602]	1775 [838]	1600 [755]	1275 [602]	1775 [838]	1600 [755]	1275 [602]	
DR ①		.05	.09	.12	.05	.09	.12	.05	.09	.12	
OUTDOOR DRY BULB TEMPERATURE °F [°C]	75 [23.9]	Total BTUH [kW] Sens BTUH [kW] Power	58.7 [17.2] 34.9 [10.2] 3.4	57.6 [16.9] 33.2 [9.7] 3.3	55.5 [16.3] 30.1 [8.8] 3.3	55.5 [16.3] 41.7 [12.2] 3.3	54.4 [15.9] 39.7 [11.6] 3.3	52.4 [15.4] 36.0 [10.6] 3.3	52.3 [15.3] 47.2 [13.8] 3.3	51.3 [15.0] 44.9 [13.2] 3.3	49.4 [14.5] 40.7 [11.9] 3.2
	80 [26.7]	Total BTUH [kW] Sens BTUH [kW] Power	56.9 [16.7] 34.1 [10.0] 3.5	55.8 [16.4] 32.5 [9.5] 3.5	53.7 [15.7] 29.4 [8.6] 3.4	53.7 [15.7] 41.0 [12.0] 3.5	52.6 [15.4] 39.0 [11.4] 3.5	50.7 [14.9] 35.3 [10.3] 3.4	50.4 [14.8] 46.4 [13.6] 3.5	49.5 [14.5] 44.2 [13.0] 3.5	47.6 [14.0] 40.0 [11.7] 3.4
	85 [29.4]	Total BTUH [kW] Sens BTUH [kW] Power	55.1 [16.1] 33.3 [9.8] 3.7	54.0 [15.8] 31.7 [9.3] 3.7	52.0 [15.2] 28.7 [8.4] 3.6	51.8 [15.2] 40.2 [11.8] 3.7	50.8 [14.9] 38.2 [11.2] 3.6	49.0 [14.4] 34.6 [10.1] 3.6	48.6 [14.2] 45.6 [13.4] 3.7	47.7 [14.0] 43.4 [12.7] 3.6	45.9 [13.5] 39.3 [11.5] 3.6
	90 [32.2]	Total BTUH [kW] Sens BTUH [kW] Power	53.2 [15.6] 32.5 [9.5] 3.9	52.2 [15.3] 30.9 [9.1] 3.8	50.3 [14.7] 28.0 [8.2] 3.8	50.0 [14.7] 39.4 [11.5] 3.9	49.0 [14.4] 37.5 [11.0] 3.8	47.2 [13.8] 33.9 [9.9] 3.8	46.8 [13.7] 44.8 [13.1] 3.8	45.9 [13.5] 42.7 [12.5] 3.8	44.2 [13.0] 38.6 [11.3] 3.7
	95 [35]	Total BTUH [kW] Sens BTUH [kW] Power	51.4 [15.1] 31.7 [9.3] 4.1	50.4 [14.8] 30.2 [8.9] 4.0	48.5 [14.2] 27.3 [8.0] 4.0	48.2 [14.1] 38.6 [11.3] 4.1	47.2 [13.8] 36.7 [10.8] 4.0	45.5 [13.3] 33.2 [9.7] 3.9	44.9 [13.2] 44.0 [12.9] 4.0	44.1 [12.9] 41.9 [12.3] 4.0	42.4 [12.4] 37.9 [11.1] 3.9
	100 [37.8]	Total BTUH [kW] Sens BTUH [kW] Power	49.6 [14.5] 30.9 [9.1] 4.3	48.6 [14.2] 29.4 [8.6] 4.2	46.8 [13.7] 26.6 [7.8] 4.2	46.3 [13.6] 37.7 [11.0] 4.3	45.4 [13.3] 35.9 [10.5] 4.2	43.7 [12.8] 32.5 [9.5] 4.1	43.1 [12.6] 43.1 [12.6] 4.2	42.3 [12.4] 41.1 [12.0] 4.2	40.7 [11.9] 37.2 [10.9] 4.1
	105 [40.6]	Total BTUH [kW] Sens BTUH [kW] Power	47.7 [14.0] 30.0 [8.8] 4.5	46.8 [13.7] 28.6 [8.4] 4.4	45.1 [13.2] 25.9 [7.6] 4.4	44.5 [13.0] 36.9 [10.8] 4.5	43.6 [12.8] 35.1 [10.3] 4.4	42.0 [12.3] 31.8 [9.3] 4.3	41.3 [12.1] 41.3 [12.1] 4.4	40.5 [11.9] 40.3 [11.8] 4.4	39.0 [11.4] 36.5 [10.7] 4.3
	110 [43.3]	Total BTUH [kW] Sens BTUH [kW] Power	45.9 [13.5] 29.2 [8.6] 4.7	45.0 [13.2] 27.8 [8.1] 4.7	43.3 [12.7] 25.2 [7.4] 4.6	42.7 [12.5] 36.1 [10.6] 4.7	41.8 [12.3] 34.3 [10.1] 4.6	40.3 [11.8] 31.1 [9.1] 4.6	39.4 [11.5] 39.4 [11.5] 4.7	38.7 [11.3] 38.7 [11.3] 4.6	37.2 [10.9] 35.8 [10.5] 4.5
	115 [46.1]	Total BTUH [kW] Sens BTUH [kW] Power	44.1 [12.9] 28.4 [8.3] 4.9	43.2 [12.7] 27.0 [7.9] 4.9	41.6 [12.2] 24.4 [7.2] 4.8	40.8 [12.0] 35.2 [10.3] 4.9	40.0 [11.7] 33.5 [9.8] 4.9	38.5 [11.3] 30.3 [8.9] 4.8	37.6 [11.0] 37.6 [11.0] 4.9	36.9 [10.8] 36.9 [10.8] 4.8	35.5 [10.4] 35.0 [10.3] 4.8
	120 [48.9]	Total BTUH [kW] Sens BTUH [kW] Power	42.2 [12.4] 27.5 [8.1] 5.2	41.4 [12.1] 26.2 [7.7] 5.1	39.9 [11.7] 23.7 [6.9] 5.0	39.0 [11.4] 34.3 [10.1] 5.1	38.2 [11.2] 32.7 [9.6] 5.1	36.8 [10.8] 29.6 [8.7] 5.0	35.8 [10.5] 35.8 [10.5] 5.1	35.1 [10.3] 35.1 [10.3] 5.1	33.8 [9.9] 33.8 [9.9] 5.0
	125 [51.7]	Total BTUH [kW] Sens BTUH [kW] Power	40.4 [11.8] 26.6 [7.8] 5.4	39.6 [11.6] 25.3 [7.4] 5.4	38.1 [11.2] 22.9 [6.7] 5.3	37.2 [10.9] 33.5 [9.8] 5.4	36.4 [10.7] 31.8 [9.3] 5.3	35.1 [10.3] 28.8 [8.4] 5.2	33.9 [9.9] 33.9 [9.9] 5.4	33.3 [9.8] 33.3 [9.8] 5.3	32.0 [9.4] 32.0 [9.4] 5.2

DR —Depression ratio
dbE —Entering air dry bulb
wbE—Entering air wet bulb

Total —Total capacity x 1000 BTUH
Sens —Sensible capacity x 1000 BTUH
Power —KW input

NOTES: ① When the entering air dry bulb is other than 80°F [27°C], adjust the sensible capacity from the table by adding [1.10 x CFM x (1 – DR) x (dbE – 80)].

[] Designates Metric Conversions

GROSS SYSTEMS COOLING PERFORMANCE DATA—RHPBZR060AJT000NA

ENTERING INDOOR AIR @ 80°F [26.7°C] dbE ①											
wbE		71°F [21.7°C]			67°F [19.4°C]			63°F [17.2°C]			
CFM [L/s]		2175 [1026]	2000 [944]	1575 [743]	2175 [1026]	2000 [944]	1575 [743]	2175 [1026]	2000 [944]	1575 [743]	
DR ①		.05	.09	.12	.05	.09	.12	.05	.09	.12	
OUTDOOR DRY BULB TEMPERATURE °F [°C]	75 [23.9]	Total BTUH [kW] Sens BTUH [kW] Power	72.1 [21.1] 43.2 [12.7] 4.5	71.0 [20.8] 41.5 [12.2] 4.4	68.3 [20.0] 37.4 [11.0] 4.3	67.2 [19.7] 51.7 [15.2] 4.4	66.1 [19.4] 49.7 [14.6] 4.4	63.6 [18.6] 44.7 [13.1] 4.3	63.6 [18.6] 59.6 [17.5] 4.3	62.6 [18.3] 57.2 [16.8] 4.3	60.2 [17.6] 51.5 [15.1] 4.2
	80 [26.7]	Total BTUH [kW] Sens BTUH [kW] Power	70.2 [20.6] 42.1 [12.3] 4.6	69.1 [20.3] 40.4 [11.8] 4.6	66.4 [19.5] 36.4 [10.7] 4.5	65.2 [19.1] 50.6 [14.8] 4.6	64.2 [18.8] 48.6 [14.2] 4.5	61.7 [18.1] 43.8 [12.8] 4.4	61.7 [18.1] 58.5 [17.1] 4.5	60.7 [17.8] 56.2 [16.5] 4.5	58.4 [17.1] 50.6 [14.8] 4.4
	85 [29.4]	Total BTUH [kW] Sens BTUH [kW] Power	68.1 [20.0] 40.9 [12.0] 4.8	67.0 [19.6] 39.3 [11.5] 4.8	64.4 [18.9] 35.4 [10.4] 4.7	63.2 [18.5] 49.5 [14.5] 4.7	62.2 [18.2] 47.5 [13.9] 4.7	59.8 [17.5] 42.8 [12.5] 4.6	59.6 [17.5] 57.3 [16.8] 4.7	58.7 [17.2] 55.1 [16.1] 4.7	56.4 [16.5] 49.6 [14.5] 4.6
	90 [32.2]	Total BTUH [kW] Sens BTUH [kW] Power	65.9 [19.3] 39.8 [11.7] 5.0	64.9 [19.0] 38.3 [11.2] 5.0	62.4 [18.3] 34.5 [10.1] 4.9	61.0 [17.9] 48.4 [14.2] 4.9	60.0 [17.6] 46.5 [13.6] 4.9	57.7 [16.9] 41.8 [12.3] 4.8	57.4 [16.8] 56.2 [16.5] 4.9	56.5 [16.6] 54.0 [15.8] 4.8	54.3 [15.9] 48.7 [14.3] 4.8
	95 [35]	Total BTUH [kW] Sens BTUH [kW] Power	63.6 [18.6] 38.7 [11.3] 5.2	62.6 [18.3] 37.2 [10.9] 5.2	60.2 [17.6] 33.5 [9.8] 5.1	58.7 [17.2] 47.2 [13.8] 5.2	57.8 [16.9] 45.4 [13.3] 5.1	55.5 [16.3] 40.9 [12.0] 5.0	55.2 [16.2] 55.1 [16.1] 5.1	54.3 [15.9] 52.9 [15.5] 5.1	52.2 [15.3] 47.7 [14.0] 5.0
	100 [37.8]	Total BTUH [kW] Sens BTUH [kW] Power	61.2 [17.9] 37.5 [11.0] 5.4	60.3 [17.7] 36.0 [10.6] 5.4	58.0 [17.0] 32.5 [9.5] 5.3	56.3 [16.5] 46.0 [13.5] 5.4	55.4 [16.2] 44.2 [13.0] 5.3	53.3 [15.6] 39.8 [11.7] 5.2	52.8 [15.5] 52.8 [15.5] 5.3	51.9 [15.2] 51.8 [15.2] 5.3	49.9 [14.6] 46.7 [13.7] 5.2
	105 [40.6]	Total BTUH [kW] Sens BTUH [kW] Power	58.8 [17.2] 36.3 [10.6] 5.7	57.8 [16.9] 34.9 [10.2] 5.6	55.6 [16.3] 31.4 [9.2] 5.5	53.8 [15.8] 44.9 [13.2] 5.6	53.0 [15.5] 43.1 [12.6] 5.6	50.9 [14.9] 38.8 [11.4] 5.5	50.3 [14.7] 50.3 [14.7] 5.6	49.5 [14.5] 49.5 [14.5] 5.5	47.6 [14.0] 45.6 [13.4] 5.4
	110 [43.3]	Total BTUH [kW] Sens BTUH [kW] Power	56.2 [16.5] 35.1 [10.3] 5.9	55.3 [16.2] 33.7 [9.9] 5.9	53.2 [15.6] 30.4 [8.9] 5.8	51.2 [15.0] 43.7 [12.8] 5.9	50.4 [14.8] 41.9 [12.3] 5.8	48.5 [14.2] 37.8 [11.1] 5.7	47.7 [14.0] 47.7 [14.0] 5.8	46.9 [13.7] 46.9 [13.7] 5.8	45.1 [13.2] 44.6 [13.1] 5.7
	115 [46.1]	Total BTUH [kW] Sens BTUH [kW] Power	53.5 [15.7] 33.9 [9.9] 6.2	52.6 [15.4] 32.6 [9.6] 6.2	50.6 [14.8] 29.3 [8.6] 6.0	48.5 [14.2] 42.4 [12.4] 6.2	47.8 [14.0] 40.8 [12.0] 6.1	45.9 [13.5] 36.7 [10.8] 6.0	45.0 [13.2] 45.0 [13.2] 6.1	44.3 [13.0] 44.3 [13.0] 6.0	42.6 [12.5] 42.6 [12.5] 5.9
	120 [48.9]	Total BTUH [kW] Sens BTUH [kW] Power	50.7 [14.9] 32.7 [9.6] 6.5	49.9 [14.6] 31.4 [9.2] 6.4	47.9 [14.0] 28.3 [8.3] 6.3	45.7 [13.4] 41.2 [12.1] 6.4	45.0 [13.2] 39.6 [11.6] 6.4	43.3 [12.7] 35.7 [10.5] 6.3	42.2 [12.4] 42.2 [12.4] 6.4	41.5 [12.2] 41.5 [12.2] 6.3	39.9 [11.7] 39.9 [11.7] 6.2
125 [51.7]	Total BTUH [kW] Sens BTUH [kW] Power	47.8 [14.0] 31.4 [9.2] 6.8	47.0 [13.8] 30.2 [8.9] 6.8	45.2 [13.2] 27.2 [8.0] 6.6	42.8 [12.5] 40.0 [11.7] 6.7	42.2 [12.4] 38.4 [11.3] 6.7	40.5 [11.9] 34.6 [10.1] 6.6	39.3 [11.5] 39.3 [11.5] 6.7	38.7 [11.3] 38.7 [11.3] 6.6	37.2 [10.9] 37.2 [10.9] 6.5	

DR —Depression ratio
dbE —Entering air dry bulb
wbE—Entering air wet bulb

Total —Total capacity x 1000 BTUH
Sens —Sensible capacity x 1000 BTUH
Power —KW input

NOTES: ① When the entering air dry bulb is other than 80°F [27°C], adjust the sensible capacity from the table by adding [1.10 x CFM x (1 – DR) x (dbE – 80)].

[] Designates Metric Conversions

HEATING PERFORMANCE DATA – RHPBZR024AJT000NA

IDB		60°F [15.5°C]			70°F [21.1°C]			80°F [26.7°C]			
		CFM [L/s]	850 [401]	800 [378]	600 [283]	850 [401]	800 [378]	600 [283]	850 [401]	800 [378]	640 [302]
OUTDOOR DRY BULB TEMPERATURE	0 [-17.8]	Total BTUH [kW] Power	7.7 [2.3] 1.6	7.6 [2.2] 1.6	7.5 [2.2] 1.7	6.8 [2.0] 1.8	6.8 [2.0] 1.8	6.7 [2.0] 1.9	5.9 [1.7] 2.0	5.9 [1.7] 2.0	5.8 [1.7] 2.0
	5 [-15]	Total BTUH [kW] Power	9.4 [2.8] 1.6	9.3 [2.7] 1.6	9.2 [2.7] 1.7	8.5 [2.5] 1.8	8.5 [2.5] 1.8	8.3 [2.4] 1.9	7.6 [2.2] 1.9	7.6 [2.2] 2.0	7.5 [2.2] 2.0
	10 [-12.2]	Total BTUH [kW] Power	11.1 [3.3] 1.6	11.0 [3.2] 1.6	10.8 [3.2] 1.7	10.2 [3.0] 1.8	10.1 [3.0] 1.8	10.0 [2.9] 1.8	9.3 [2.7] 1.9	9.3 [2.7] 2.0	9.1 [2.7] 2.0
	15 [-9.4]	Total BTUH [kW] Power	12.7 [3.7] 1.6	12.7 [3.7] 1.6	12.5 [3.7] 1.7	11.9 [3.5] 1.8	11.8 [3.5] 1.8	11.6 [3.4] 1.9	11.0 [3.2] 1.9	11.0 [3.2] 2.0	10.8 [3.2] 2.0
	20 [-6.7]	Total BTUH [kW] Power	14.4 [4.2] 1.6	14.4 [4.2] 1.6	14.1 [4.1] 1.7	13.6 [4.0] 1.8	13.5 [4.0] 1.8	13.3 [3.9] 1.9	12.7 [3.7] 2.0	12.6 [3.7] 2.0	12.4 [3.6] 2.0
	25 [-3.9]	Total BTUH [kW] Power	16.1 [4.7] 1.6	16.0 [4.7] 1.7	15.8 [4.6] 1.7	15.3 [4.5] 1.8	15.2 [4.5] 1.8	14.9 [4.4] 1.9	14.4 [4.2] 2.0	14.3 [4.2] 2.0	14.1 [4.1] 2.0
	30 [-1.1]	Total BTUH [kW] Power	17.8 [5.2] 1.7	17.7 [5.2] 1.7	17.4 [5.1] 1.7	16.9 [5.0] 1.8	16.9 [5.0] 1.8	16.6 [4.9] 1.9	16.1 [4.7] 2.0	16.0 [4.7] 2.0	15.7 [4.6] 2.1
	35 [1.7]	Total BTUH [kW] Power	19.5 [5.7] 1.7	19.4 [5.7] 1.7	19.1 [5.6] 1.8	18.6 [5.5] 1.9	18.5 [5.4] 1.9	18.2 [5.3] 1.9	17.8 [5.2] 2.0	17.7 [5.2] 2.0	17.4 [5.1] 2.1
	40 [4.4]	Total BTUH [kW] Power	21.2 [6.2] 1.7	21.1 [6.2] 1.7	20.7 [6.1] 1.8	20.3 [5.9] 1.9	20.2 [5.9] 1.9	19.9 [5.8] 2.0	19.4 [5.7] 2.0	19.4 [5.7] 2.1	19.0 [5.6] 2.1
	45 [7.2]	Total BTUH [kW] Power	22.9 [6.7] 1.8	22.8 [6.7] 1.8	22.4 [6.6] 1.8	22.0 [6.4] 1.9	21.9 [6.4] 1.9	21.5 [6.3] 2.0	21.1 [6.2] 2.1	21.0 [6.2] 2.1	20.7 [6.1] 2.2
50 [10]	Total BTUH [kW] Power	24.6 [7.2] 1.8	24.5 [7.2] 1.8	24.0 [7.0] 1.9	23.7 [6.9] 2.0	23.6 [6.9] 2.0	23.2 [6.8] 2.0	22.8 [6.7] 2.1	22.7 [6.7] 2.1	22.3 [6.5] 2.2	

IDB —Indoor air dry bulb

HEATING PERFORMANCE DATA – RHPBZR030AJT000NA

IDB		60°F [15.5°C]			70°F [21.1°C]			80°F [26.7°C]			
		CFM [L/s]	1025 [484]	1000 [472]	750 [354]	1025 [484]	1000 [472]	750 [354]	1025 [484]	1000 [472]	750 [354]
OUTDOOR DRY BULB TEMPERATURE	0 [-17.8]	Total BTUH [kW] Power	9.1 [2.7] 1.8	9.1 [2.7] 1.8	8.9 [2.6] 1.9	8.5 [2.5] 2.0	8.5 [2.5] 2.0	8.3 [2.4] 2.1	7.9 [2.3] 2.2	7.9 [2.3] 2.2	7.8 [2.3] 2.3
	5 [-15]	Total BTUH [kW] Power	11.1 [3.3] 1.8	11.1 [3.3] 1.8	10.9 [3.2] 1.9	10.5 [3.1] 2.0	10.5 [3.1] 2.0	10.3 [3.0] 2.1	9.9 [2.9] 2.2	9.9 [2.9] 2.2	9.7 [2.8] 2.3
	10 [-12.2]	Total BTUH [kW] Power	13.1 [3.8] 1.8	13.1 [3.8] 1.8	12.8 [3.8] 1.9	12.5 [3.7] 2.0	12.5 [3.7] 2.0	12.3 [3.6] 2.1	11.9 [3.5] 2.2	11.9 [3.5] 2.2	11.7 [3.4] 2.3
	15 [-9.4]	Total BTUH [kW] Power	15.1 [4.4] 1.8	15.0 [4.4] 1.8	14.8 [4.3] 1.9	14.5 [4.2] 2.0	14.5 [4.2] 2.0	14.2 [4.2] 2.1	13.9 [4.1] 2.2	13.9 [4.1] 2.2	13.6 [4.0] 2.3
	20 [-6.7]	Total BTUH [kW] Power	17.1 [5.0] 1.8	17.0 [5.0] 1.8	16.7 [4.9] 1.9	16.5 [4.8] 2.0	16.5 [4.8] 2.0	16.2 [4.7] 2.1	15.9 [4.7] 2.2	15.9 [4.7] 2.2	15.6 [4.6] 2.3
	25 [-3.9]	Total BTUH [kW] Power	19.1 [5.6] 1.9	19.0 [5.6] 1.9	18.7 [5.5] 1.9	18.5 [5.4] 2.1	18.5 [5.4] 2.1	18.1 [5.3] 2.1	17.9 [5.2] 2.3	17.9 [5.2] 2.3	17.6 [5.2] 2.3
	30 [-1.1]	Total BTUH [kW] Power	21.1 [6.2] 1.9	21.0 [6.2] 1.9	20.7 [6.1] 2.0	20.5 [6.0] 2.1	20.5 [6.0] 2.1	20.1 [5.9] 2.2	19.9 [5.8] 2.3	19.9 [5.8] 2.3	19.5 [5.7] 2.4
	35 [1.7]	Total BTUH [kW] Power	23.1 [6.8] 1.9	23.0 [6.7] 1.9	22.6 [6.6] 2.0	22.5 [6.6] 2.1	22.5 [6.6] 2.1	22.1 [6.5] 2.2	21.9 [6.4] 2.3	21.9 [6.4] 2.3	21.5 [6.3] 2.4
	40 [4.4]	Total BTUH [kW] Power	25.1 [7.4] 2.0	25.0 [7.3] 2.0	24.6 [7.2] 2.0	24.5 [7.2] 2.2	24.5 [7.2] 2.2	24.0 [7.0] 2.2	23.9 [7.0] 2.4	23.9 [7.0] 2.4	23.5 [6.9] 2.4
	45 [7.2]	Total BTUH [kW] Power	27.1 [7.9] 2.0	27.0 [7.9] 2.0	26.6 [7.8] 2.1	26.5 [7.8] 2.2	26.5 [7.8] 2.2	26.0 [7.6] 2.3	25.9 [7.6] 2.4	25.9 [7.6] 2.4	25.4 [7.4] 2.5
50 [10]	Total BTUH [kW] Power	29.1 [8.5] 2.1	29.0 [8.5] 2.1	28.5 [8.4] 2.2	28.5 [8.4] 2.3	28.5 [8.4] 2.3	28.0 [8.2] 2.4	27.9 [8.2] 2.5	27.9 [8.2] 2.5	27.4 [8.0] 2.6	

IDB —Indoor air dry bulb

[] Designates Metric Conversions

HEATING PERFORMANCE DATA—RHPBZR036AJT000NA

IDB		60°F [15.5°C]			70°F [21.1°C]			80°F [26.7°C]			
		CFM [L/s]	1400 [661]	1200 [566]	1000 [472]	1400 [661]	1200 [566]	1000 [472]	1400 [661]	1200 [566]	1000 [472]
OUTDOOR DRY BULB TEMPERATURE °F [°C]	0 [-17.8]	Total BTUH [kW] Power	12.7 [3.7] 2.1	12.5 [3.7] 2.2	12.4 [3.6] 2.2	11.8 [3.5] 2.4	11.7 [3.4] 2.5	11.5 [3.4] 2.6	10.9 [3.2] 2.8	10.8 [3.2] 2.8	10.7 [3.1] 2.9
	5 [-15]	Total BTUH [kW] Power	15.4 [4.5] 2.2	15.2 [4.5] 2.3	15.1 [4.4] 2.3	14.5 [4.2] 2.5	14.4 [4.2] 2.6	14.2 [4.2] 2.6	13.7 [4.0] 2.8	13.5 [4.0] 2.9	13.3 [3.9] 3.0
	10 [-12.2]	Total BTUH [kW] Power	18.2 [5.3] 2.3	18 [5.3] 2.3	17.7 [5.2] 2.4	17.3 [5.1] 2.6	17.1 [5.0] 2.7	16.9 [5.0] 2.7	16.4 [4.8] 2.9	16.2 [4.7] 3.0	16 [4.7] 3.0
	15 [-9.4]	Total BTUH [kW] Power	20.9 [6.1] 2.4	20.7 [6.1] 2.4	20.4 [6.0] 2.5	20.0 [5.9] 2.7	19.8 [5.8] 2.7	19.6 [5.7] 2.8	19.2 [5.6] 3.0	18.9 [5.5] 3.1	18.7 [5.5] 3.1
	20 [-6.7]	Total BTUH [kW] Power	23.7 [6.9] 2.4	23.4 [6.9] 2.5	23.1 [6.8] 2.5	22.8 [6.7] 2.8	22.5 [6.6] 2.8	22.2 [6.5] 2.9	21.9 [6.4] 3.1	21.6 [6.3] 3.1	21.4 [6.3] 3.2
	25 [-3.9]	Total BTUH [kW] Power	26.4 [7.7] 2.5	26.1 [7.6] 2.6	25.8 [7.6] 2.6	25.5 [7.5] 2.8	25.2 [7.4] 2.9	24.9 [7.3] 3.0	24.6 [7.2] 3.1	24.3 [7.1] 3.2	24.1 [7.1] 3.3
	30 [-1.1]	Total BTUH [kW] Power	29.1 [8.5] 2.6	28.8 [8.4] 2.7	28.5 [8.4] 2.7	28.3 [8.3] 2.9	27.9 [8.2] 3.0	27.6 [8.1] 3.0	27.4 [8.0] 3.2	27.1 [7.9] 3.3	26.7 [7.8] 3.4
	35 [1.7]	Total BTUH [kW] Power	31.9 [9.3] 2.7	31.5 [9.2] 2.7	31.1 [9.1] 2.8	31.0 [9.1] 3.0	30.6 [9] 3.1	30.3 [8.9] 3.1	30.1 [8.8] 3.3	29.8 [8.7] 3.4	29.4 [8.6] 3.5
	40 [4.4]	Total BTUH [kW] Power	34.6 [10.1] 2.8	34.2 [10.0] 2.8	33.8 [9.9] 2.9	33.7 [9.9] 3.1	33.4 [9.8] 3.1	33.0 [9.7] 3.2	32.9 [9.6] 3.4	32.5 [9.5] 3.5	32.1 [9.4] 3.5
	45 [7.2]	Total BTUH [kW] Power	37.4 [11] 2.9	36.9 [10.8] 2.9	36.5 [10.7] 3.0	36.5 [10.7] 3.2	36.1 [10.6] 3.2	35.6 [10.4] 3.3	35.6 [10.4] 3.5	35.2 [10.3] 3.6	34.8 [10.2] 3.6
50 [10]	Total BTUH [kW] Power	40.1 [11.8] 2.9	39.6 [11.6] 3.0	39.2 [11.5] 3.1	39.2 [11.5] 3.3	38.8 [11.4] 3.3	38.3 [11.2] 3.4	38.4 [11.3] 3.6	37.9 [11.1] 3.7	37.5 [11.0] 3.7	

IDB —Indoor air dry bulb

HEATING PERFORMANCE DATA—RHPBZR042AJT000NA

IDB		60°F [15.5°C]			70°F [21.1°C]			80°F [26.7°C]			
		CFM [L/s]	1550 [732]	1400 [661]	1125 [531]	1550 [732]	1400 [661]	1125 [531]	1550 [732]	1400 [661]	1125 [531]
OUTDOOR DRY BULB TEMPERATURE °F [°C]	0 [-17.8]	Total BTUH [kW] Power	13.5 [4.0] 2.2	13.4 [3.9] 2.2	13.2 [3.9] 2.2	11.9 [3.5] 2.4	11.8 [3.5] 2.4	11.6 [3.4] 2.5	10.2 [3.0] 2.7	10.1 [3.0] 2.7	10.0 [2.9] 2.8
	5 [-15]	Total BTUH [kW] Power	16.7 [4.9] 2.3	16.6 [4.9] 2.4	16.4 [4.8] 2.4	15.0 [4.4] 2.6	14.9 [4.4] 2.6	14.7 [4.3] 2.7	13.4 [3.9] 2.9	13.3 [3.9] 2.9	13.1 [3.8] 3.0
	10 [-12.2]	Total BTUH [kW] Power	19.9 [5.8] 2.5	19.8 [5.8] 2.5	19.5 [5.7] 2.6	18.2 [5.3] 2.8	18.1 [5.3] 2.8	17.8 [5.2] 2.9	16.6 [4.9] 3.0	16.4 [4.8] 3.1	16.2 [4.7] 3.1
	15 [-9.4]	Total BTUH [kW] Power	23.1 [6.8] 2.7	22.9 [6.7] 2.7	22.6 [6.6] 2.8	21.4 [6.3] 2.9	21.3 [6.2] 3.0	21.0 [6.2] 3.0	19.7 [5.8] 3.2	19.6 [5.7] 3.2	19.3 [5.7] 3.3
	20 [-6.7]	Total BTUH [kW] Power	26.3 [7.7] 2.8	26.1 [7.6] 2.9	25.7 [7.5] 2.9	24.6 [7.2] 3.1	24.4 [7.2] 3.1	24.1 [7.1] 3.2	22.9 [6.7] 3.3	22.8 [6.7] 3.4	22.4 [6.6] 3.5
	25 [-3.9]	Total BTUH [kW] Power	29.5 [8.6] 2.9	29.3 [8.6] 3.0	28.9 [8.5] 3.1	27.8 [8.1] 3.2	27.6 [8.1] 3.2	27.2 [8.0] 3.3	26.1 [7.6] 3.5	25.9 [7.6] 3.5	25.6 [7.5] 3.6
	30 [-1.1]	Total BTUH [kW] Power	32.7 [9.6] 3.1	32.4 [9.5] 3.1	32.0 [9.4] 3.2	31.0 [9.1] 3.3	30.8 [9.0] 3.4	30.3 [8.9] 3.4	29.3 [8.6] 3.6	29.1 [8.5] 3.6	28.7 [8.4] 3.7
	35 [1.7]	Total BTUH [kW] Power	35.9 [10.5] 3.2	35.6 [10.4] 3.2	35.1 [10.3] 3.3	34.2 [10.0] 3.4	33.9 [9.9] 3.5	33.4 [9.8] 3.5	32.5 [9.5] 3.7	32.3 [9.5] 3.7	31.8 [9.3] 3.8
	40 [4.4]	Total BTUH [kW] Power	39.1 [11.5] 3.2	38.8 [11.4] 3.3	38.2 [11.2] 3.4	37.4 [11.0] 3.5	37.1 [10.9] 3.6	36.6 [10.7] 3.6	35.7 [10.5] 3.8	35.4 [10.4] 3.8	34.9 [10.2] 3.9
	45 [7.2]	Total BTUH [kW] Power	42.2 [12.4] 3.3	41.9 [12.3] 3.4	41.3 [12.1] 3.4	40.6 [11.9] 3.6	40.3 [11.8] 3.6	39.7 [11.6] 3.7	38.9 [11.4] 3.8	38.6 [11.3] 3.9	38 [11.1] 4.0
50 [10]	Total BTUH [kW] Power	45.4 [13.3] 3.4	45.1 [13.2] 3.4	44.5 [13.0] 3.5	43.8 [12.8] 3.6	43.4 [12.7] 3.7	42.8 [12.5] 3.8	42.1 [12.3] 3.9	41.8 [12.3] 3.9	41.2 [12.1] 4.0	

IDB —Indoor air dry bulb

[] Designates Metric Conversions

HEATING PERFORMANCE DATA—RHPBZR048AJT000NA

IDB		60°F [15.5°C]			70°F [21.1°C]			80°F [26.7°C]			
		CFM [L/s]	1750 [826]	1600 [755]	1275 [602]	1750 [826]	1600 [755]	1275 [602]	1750 [826]	1600 [755]	1275 [602]
OUTDOOR DRY BULB TEMPERATURE °F [°C]	0 [-17.8]	Total BTUH [kW] Power	13.0 [3.8] 3.2	12.9 [3.8] 3.3	12.7 [3.7] 3.4	11.5 [3.4] 3.6	11.5 [3.4] 3.6	11.3 [3.3] 3.7	10.1 [3.0] 4.0	10.0 [2.9] 4.0	9.9 [2.9] 4.1
	5 [-15]	Total BTUH [kW] Power	16.8 [4.9] 3.2	16.7 [4.9] 3.2	16.4 [4.8] 3.3	15.3 [4.5] 3.6	15.2 [4.5] 3.6	15.0 [4.4] 3.7	13.8 [4.0] 3.9	13.7 [4.0] 4.0	13.5 [4.0] 4.1
	10 [-12.2]	Total BTUH [kW] Power	20.5 [6.0] 3.2	20.4 [6.0] 3.2	20.1 [5.9] 3.3	19.1 [5.6] 3.5	18.9 [5.5] 3.6	18.7 [5.5] 3.7	17.6 [5.2] 3.9	17.5 [5.1] 3.9	17.2 [5.0] 4.0
	15 [-9.4]	Total BTUH [kW] Power	24.3 [7.1] 3.2	24.1 [7.1] 3.2	23.8 [7.0] 3.3	22.8 [6.7] 3.5	22.7 [6.7] 3.6	22.4 [6.6] 3.7	21.4 [6.3] 3.9	21.2 [6.2] 3.9	20.9 [6.1] 4.0
	20 [-6.7]	Total BTUH [kW] Power	28.1 [8.2] 3.2	27.9 [8.2] 3.3	27.5 [8.1] 3.3	26.6 [7.8] 3.6	26.4 [7.7] 3.6	26.0 [7.6] 3.7	25.1 [7.4] 3.9	25.0 [7.3] 4.0	24.6 [7.2] 4.1
	25 [-3.9]	Total BTUH [kW] Power	31.8 [9.3] 3.3	31.6 [9.3] 3.3	31.2 [9.1] 3.4	30.4 [8.9] 3.6	30.2 [8.9] 3.7	29.7 [8.7] 3.8	28.9 [8.5] 4.0	28.7 [8.4] 4.0	28.3 [8.3] 4.1
	30 [-1.1]	Total BTUH [kW] Power	35.6 [10.4] 3.3	35.4 [10.4] 3.4	34.9 [10.2] 3.5	34.1 [10.0] 3.7	33.9 [9.9] 3.7	33.4 [9.8] 3.8	32.7 [9.6] 4.1	32.4 [9.5] 4.1	32.0 [9.4] 4.2
	35 [1.7]	Total BTUH [kW] Power	39.4 [11.5] 3.4	39.1 [11.5] 3.5	38.5 [11.3] 3.6	37.9 [11.1] 3.8	37.6 [11.0] 3.8	37.1 [10.9] 3.9	36.4 [10.7] 4.2	36.2 [10.6] 4.2	35.7 [10.5] 4.3
	40 [4.4]	Total BTUH [kW] Power	43.1 [12.6] 3.6	42.8 [12.5] 3.6	42.2 [12.4] 3.7	41.7 [12.2] 3.9	41.4 [12.1] 4.0	40.8 [12.0] 4.1	40.2 [11.8] 4.3	39.9 [11.7] 4.3	39.3 [11.5] 4.4
	45 [7.2]	Total BTUH [kW] Power	46.9 [13.7] 3.7	46.6 [13.7] 3.8	45.9 [13.5] 3.9	45.4 [13.3] 4.1	45.1 [13.2] 4.1	44.5 [13.0] 4.2	44 [12.9] 4.4	43.7 [12.8] 4.5	43 [12.6] 4.6
50 [10]	Total BTUH [kW] Power	50.7 [14.9] 3.9	50.3 [14.7] 3.9	49.6 [14.5] 4.0	49.2 [14.4] 4.3	48.9 [14.3] 4.3	48.2 [14.1] 4.4	47.7 [14.0] 4.6	47.4 [13.9] 4.7	46.7 [13.7] 4.8	

IDB —Indoor air dry bulb

HEATING PERFORMANCE DATA—RHPBZR060AJT000NA

IDB		60°F [15.5°C]			70°F [21.1°C]			80°F [26.7°C]			
		CFM [L/s]	2175 [1026]	2000 [944]	1575 [743]	2175 [1026]	2000 [944]	1575 [743]	2175 [1026]	2000 [944]	1575 [743]
OUTDOOR DRY BULB TEMPERATURE °F [°C]	0 [-17.8]	Total BTUH [kW] Power	17.2 [5.0] 3.6	17.1 [5.0] 3.7	16.8 [4.9] 3.8	15.1 [4.4] 4.0	15.0 [4.4] 4.1	14.8 [4.3] 4.2	13.1 [3.8] 4.4	13.0 [3.8] 4.5	12.8 [3.8] 4.6
	5 [-15]	Total BTUH [kW] Power	21.8 [6.4] 3.7	21.6 [6.3] 3.7	21.3 [6.2] 3.8	19.7 [5.8] 4.1	19.6 [5.7] 4.1	19.3 [5.7] 4.2	17.7 [5.2] 4.4	17.6 [5.2] 4.5	17.3 [5.1] 4.6
	10 [-12.2]	Total BTUH [kW] Power	26.3 [7.7] 3.7	26.2 [7.7] 3.8	25.8 [7.6] 3.9	24.3 [7.1] 4.1	24.1 [7.1] 4.2	23.8 [7.0] 4.3	22.2 [6.5] 4.5	22.1 [6.5] 4.5	21.8 [6.4] 4.7
	15 [-9.4]	Total BTUH [kW] Power	30.9 [9.1] 3.8	30.7 [9.0] 3.8	30.3 [8.9] 3.9	28.9 [8.5] 4.2	28.7 [8.4] 4.2	28.3 [8.3] 4.3	26.8 [7.9] 4.6	26.7 [7.8] 4.6	26.3 [7.7] 4.7
	20 [-6.7]	Total BTUH [kW] Power	35.5 [10.4] 3.9	35.3 [10.3] 3.9	34.7 [10.2] 4.0	33.4 [9.8] 4.2	33.2 [9.7] 4.3	32.7 [9.6] 4.4	31.4 [9.2] 4.6	31.2 [9.1] 4.7	30.7 [9.0] 4.8
	25 [-3.9]	Total BTUH [kW] Power	40.1 [11.8] 4.0	39.8 [11.7] 4.0	39.2 [11.5] 4.1	38 [11.1] 4.3	37.8 [11.1] 4.4	37.2 [10.9] 4.5	36.0 [10.6] 4.7	35.8 [10.5] 4.8	35.2 [10.3] 4.9
	30 [-1.1]	Total BTUH [kW] Power	44.7 [13.1] 4.1	44.4 [13] 4.1	43.7 [12.8] 4.2	42.6 [12.5] 4.4	42.3 [12.4] 4.5	41.7 [12.2] 4.6	40.6 [11.9] 4.8	40.3 [11.8] 4.9	39.7 [11.6] 5.0
	35 [1.7]	Total BTUH [kW] Power	49.2 [14.4] 4.2	48.9 [14.3] 4.2	48.2 [14.1] 4.3	47.2 [13.8] 4.6	46.9 [13.7] 4.6	46.2 [13.5] 4.7	45.1 [13.2] 4.9	44.9 [13.2] 5.0	44.2 [13.0] 5.1
	40 [4.4]	Total BTUH [kW] Power	53.8 [15.8] 4.3	53.5 [15.7] 4.4	52.7 [15.4] 4.5	51.8 [15.2] 4.7	51.4 [15.1] 4.7	50.7 [14.9] 4.9	49.7 [14.6] 5.1	49.4 [14.5] 5.1	48.7 [14.3] 5.3
	45 [7.2]	Total BTUH [kW] Power	58.4 [17.1] 4.5	58 [17.0] 4.5	57.2 [16.8] 4.6	56.3 [16.5] 4.8	56.0 [16.4] 4.9	55.2 [16.2] 5.0	54.3 [15.9] 5.2	54.0 [15.8] 5.3	53.2 [15.6] 5.4
50 [10]	Total BTUH [kW] Power	63 [18.5] 4.6	62.6 [18.3] 4.7	61.6 [18.1] 4.8	60.9 [17.8] 5.0	60.6 [17.8] 5.1	59.6 [17.5] 5.2	58.9 [17.3] 5.4	58.5 [17.1] 5.4	57.6 [16.9] 5.6	

IDB —Indoor air dry bulb

[] Designates Metric Conversions

INDOOR AIRFLOW PERFORMANCE — RHPBZR - 208/230V

Nominal Cooling Capacity Tons [kW]	Motor Speed from Factory		Manufacturer Recommended Cooling Airflow (Min/Max)	Blower Size, Motor HP [W] & # of Speeds	Motor Speed	External Static Pressure - Inches W.C. [kPa]										
	Cool	Heat				0.1 [.02]	0.2 [.05]	0.3 [.07]	0.4 [.10]	0.5 [.12]	0.6 [.15]	0.7 [.17]	0.8 [.20]	0.9 [.22]	1.0 [.25]	
2.0 [7.03]	Tap 2	Tap 2	700 CFM / 900 CFM	10x9 Blower 1/2 hp [372] 2 Speed (Constant Torque)	Low Speed Tap 1	CFM	882	818	759	650	577	512	433	368	304	241
					High Speed Tap 2	RPM	457	533	600	693	750	818	876	931	972	1015
2.5 [8.79]	Tap 2	Tap 2	1000 CFM / 1400 CFM	10x9 Blower 1/2 hp [372] 2 Speed (Constant Torque)	High Speed Tap 2	CFM	1217	1165	1113	1067	1021	920	859	830	780	728
					Low Speed Tap 1	RPM	538	597	657	715	772	864	909	946	996	1040
3.0 [10.55]	Tap 2	Tap 2	1000 CFM / 1400 CFM	12x9 Blower 3/4 hp [559] 2 Speed (Constant Torque)	High Speed Tap 2	CFM	1143	1088	1043	989	878	836	798	750	706	656
					Low Speed Tap 1	RPM	519	591	657	721	818	857	898	952	998	1049
3.5 [12.31]	Tap 2	Tap 2	1200 CFM / 1600 CFM	12x9 Blower 3/4 hp [559] 2 Speed (Constant Torque)	High Speed Tap 2	CFM	1354	1309	1265	1224	1182	1122	1028	989	957	922
					Low Speed Tap 1	RPM	577	635	689	749	806	871	954	990	1026	1062
4.0 [14.07]	Tap 2	Tap 2	1350 CFM / 1850 CFM	12x9 Blower 3/4 hp [559] 2 Speed (Constant Torque)	High Speed Tap 2	CFM	160	173	186	199	211	226	244	252	260	269
					Low Speed Tap 1	RPM	1287	1212	1136	1080	1011	945	882	828	775	726
5.0 [17.59]	Tap 2	Tap 2	1600 CFM / 2100 CFM	12x9 Blower 1 hp [746] 2 Speed (Constant Torque)	High Speed Tap 2	CFM	451	504	572	623	681	733	775	838	877	941
					Low Speed Tap 1	RPM	121	135	151	162	174	185	193	209	219	233
	Tap 2	Tap 2	1350 CFM / 1850 CFM	12x9 Blower 3/4 hp [559] 2 Speed (Constant Torque)	High Speed Tap 2	CFM	595	522	454	387	337	286	235	186	137	88
					Low Speed Tap 1	RPM	524	564	612	673	715	763	808	852	899	941
	Tap 2	Tap 2	1600 CFM / 2100 CFM	12x9 Blower 1 hp [746] 2 Speed (Constant Torque)	High Speed Tap 2	CFM	206	219	235	254	268	283	298	313	324	334
					Low Speed Tap 1	RPM	1858	1704	1655	1603	1543	1495	1446	1362	1328	1304
	Tap 2	Tap 2	1600 CFM / 2100 CFM	12x9 Blower 1 hp [746] 2 Speed (Constant Torque)	High Speed Tap 2	CFM	584	593	633	675	718	764	805	876	905	926
					Low Speed Tap 1	RPM	301	269	284	299	315	332	346	372	384	391
	Tap 2	Tap 2	1600 CFM / 2100 CFM	12x9 Blower 1 hp [746] 2 Speed (Constant Torque)	High Speed Tap 2	CFM	1592	1526	1479	1426	1361	1307	1250	1202	1147	1101
					Low Speed Tap 1	RPM	514	561	598	640	693	744	798	835	873	911
	Tap 2	Tap 2	1600 CFM / 2100 CFM	12x9 Blower 1 hp [746] 2 Speed (Constant Torque)	High Speed Tap 2	CFM	197	212	223	236	253	269	286	297	309	321
					Low Speed Tap 1	RPM	1871	1818	1766	1720	1673	1614	1573	1535	1498	1456
	Tap 2	Tap 2	1600 CFM / 2100 CFM	12x9 Blower 1 hp [746] 2 Speed (Constant Torque)	High Speed Tap 2	CFM	591	613	657	702	742	787	826	859	896	934
					Low Speed Tap 1	RPM	309	313	330	348	365	383	400	413	429	445
	Tap 2	Tap 2	1600 CFM / 2100 CFM	12x9 Blower 1 hp [746] 2 Speed (Constant Torque)	High Speed Tap 2	CFM	1871	1818	1766	1720	1673	1614	1573	1535	1498	1456
					Low Speed Tap 1	RPM	591	613	657	702	742	787	826	859	896	934
	Tap 2	Tap 2	1600 CFM / 2100 CFM	12x9 Blower 1 hp [746] 2 Speed (Constant Torque)	High Speed Tap 2	CFM	309	313	330	348	365	383	400	413	429	445
					Low Speed Tap 1	RPM	1704	1574	1467	1422	1371	1326	1265	1225	1181	1136
	Tap 2	Tap 2	1600 CFM / 2100 CFM	12x9 Blower 1 hp [746] 2 Speed (Constant Torque)	High Speed Tap 2	CFM	586	589	617	659	710	758	809	847	883	923
					Low Speed Tap 1	RPM	255	224	221	232	247	260	276	288	300	311
	Tap 2	Tap 2	1600 CFM / 2100 CFM	12x9 Blower 1 hp [746] 2 Speed (Constant Torque)	High Speed Tap 2	CFM	2189	2170	2144	2114	2083	2048	2014	1978	1947	1908
					Low Speed Tap 1	RPM	722	740	757	779	809	844	874	906	941	977
	Tap 2	Tap 2	1600 CFM / 2100 CFM	12x9 Blower 1 hp [746] 2 Speed (Constant Torque)	High Speed Tap 2	CFM	522	532	540	553	569	589	608	626	647	663
					Low Speed Tap 1	RPM	1704	1574	1467	1422	1371	1326	1265	1225	1181	1136

Notes: (1) For Constant Torque Motors: Use motor taps 3-5 to achieve rated airflow at AHRI minimum external static pressure.

DOWN DISCHARGE PRESSURE DROP (ADD TO EXTERNAL STATIC PRESSURE)							
CFM [L/s]	800 [378]	1000 [472]	1200 [566]	1400 [661]	1600 [755]	1800 [849]	2000 [944]
Pressure Drop—Includes W.C. [kPa]	.02 [.005]	.05 [.012]	.07 [.017]	.1 [.025]	.12 [.030]	.15 [.037]	.17 [.042]

[] Designates Metric Conversions

ELECTRICAL DATA - RHPBZR SERIES							
		024AJT	030AJT	036AJT	042AJT	048AJT	060AJT
Unit Information	Unit Operating Voltage Range	187-253	187-253	187-253	187-253	187-253	187-253
	Volts	208/230	208/230	208/230	208/230	208/230	208/230
	Phase	1	1	1	1	1	1
	Hz	60	60	60	60	60	60
	Minimum Circuit Ampacity	20	21	27	28	31	40
	Minimum Overcurrent Protection Device Size	25	30	40	40	45	60
	Maximum Overcurrent Protection Device Size	25	30	40	40	45	60
Compressor Motor	No.	1	1	1	1	1	1
	Volts	208/230	208/230	208/230	208/230	208/230	208/230
	Phase	1	1	1	1	1	1
	RPM	0	0	0	0	0	0
	HP, Compressor 1	0	0	0	0	0	0
	Amps (RLA), Comp. 1	10.8	11.7	15.4	15.9	18.3	23.5
	Amps (LRA), Comp. 1	55	71.3	92.1	112.3	108	118
	HP, Compressor 2						
	Amps (RLA), Comp. 2						
Amps (LRA), Comp. 2							
Condenser Motor	No.	1	1	1	1	1	1
	Volts	208/230	208/230	208/230	208/230	208/230	208/230
	Phase	1	1	1	1	1	1
	HP	1/3	1/3	1/3	1/3	1/3	1/2
	Amps (FLA, each)	1.5	1.5	1.5	1.8	1.8	2.3
	Amps (LRA, each)						
Evaporator Fan	No.	1	1	1	1	1	1
	Volts	208/230	208/230	208/230	208/230	208/230	208/230
	Phase	1	1	1	1	1	1
	HP	1/2	1/2	3/4	3/4	3/4	1
	Amps (FLA, each)	4.1	4.1	6	6	6	7.6
	Amps (LRA, each)						

208/240 VOLT, SINGLE PHASE, 60 HZ, AUXILIARY ELECTRIC HEATER KITS CHARACTERISTICS AND APPLICATION

Single Power Supply for Both Unit and Heater Kit												Separate Power Supply for Both Unit and Heater Kit					
Model Number	RXQJ-Heater Kit Nominal KW	No. of Sequence Steps	Heater Kit			Heat Pump			Heater Kit			Heat Pump					
			Rated Heater kW @ 208/240 V	Heater KBTU/Hr @ 208/240 V	Heater Amp. @ 208/240 V	Unit Min. Ampacity @ 208/240 V	Over Current Protective Device Size Min./Max. @ 208 V	Min. Ampacity 208/240V	Max. Fuse Size 208/240V	Min. Circuit Ampacity 208/240V	Over Current Protective Device Size Min./Max. @ 240 V						
RHPBZR024AJT	No Heat	—	—	—	—	20/20	25/25	—	—	20/20	25/25	25/25					
	C05J	1	3.6/4.8	12.28/16.38	17.3/20.0	41/45	45/45	22/25	25/25	20/20	25/25	25/25					
	C07J	1	5.4/7.2	18.43/24.57	26.0/30.0	52/57	60/60	33/38	35/40	20/20	25/25	25/25					
	C10J	1	7.2/9.6	24.57/32.76	34.7/40.0	63/70	80/80	44/50	45/50	20/20	25/25	25/25					
RHPBZR030AJT	No Heat	—	—	—	—	21/21	30/30	—	—	21/21	30/30	30/30					
	C05J	1	3.6/4.8	12.28/16.38	17.3/20.0	42/46	45/45	22/25	25/25	21/21	30/30	30/30					
	C07J	1	5.4/7.2	18.43/24.57	26.0/30.0	53/58	60/60	33/38	35/40	21/21	30/30	30/30					
	C10J	1	7.2/9.6	24.57/32.76	34.7/40.0	64/71	80/80	44/50	45/50	21/21	30/30	30/30					
RHPBZR036AJT	No Heat	—	—	—	—	86/96	90/90	—	—	65/75	70/80	30/30					
	C05J	1	3.6/4.8	12.28/16.38	17.3/20.0	49/52	60/60	22/25	25/25	27/27	40/40	40/40					
	C07J	1	5.4/7.2	18.43/24.57	26.0/30.0	60/65	70/70	33/38	35/40	27/27	40/40	40/40					
	C10J	1	7.2/9.6	24.57/32.76	34.7/40.0	71/77	80/80	44/50	45/50	27/27	40/40	40/40					
RHPBZR042AJT	No Heat	—	—	—	—	92/102	100/100	—	—	65/75	70/80	40/40					
	C05J	1	3.6/4.8	12.28/16.38	17.3/20.0	50/53	60/60	22/25	25/25	28/28	40/40	40/40					
	C07J	1	5.4/7.2	18.43/24.57	26.0/30.0	61/66	70/70	33/38	35/40	28/28	40/40	40/40					
	C10J	1	7.2/9.6	24.57/32.76	34.7/40.0	72/78	80/80	44/50	45/50	28/28	40/40	40/40					
RHPBZR048AJT	No Heat	—	—	—	—	93/103	100/100	—	—	65/75	70/80	40/40					
	C05J	1	3.6/4.8	12.28/16.38	17.3/20.0	53/56	60/60	22/25	25/25	31/31	45/45	45/45					
	C07J	1	5.4/7.2	18.43/24.57	26.0/30.0	64/69	70/70	33/38	35/40	31/31	45/45	45/45					
	C10J	1	7.2/9.6	24.57/32.76	34.7/40.0	75/81	80/80	44/50	45/50	31/31	45/45	45/45					
RHPBZR060AJT	No Heat	—	—	—	—	118/131	125/125	—	—	87/100	90/100	45/45					
	C05J	1	3.6/4.8	12.28/16.38	17.3/20.0	61/65	70/80	22/25	25/25	40/40	60/60	60/60					
	C07J	1	5.4/7.2	18.43/24.57	26.0/30.0	72/77	80/80	33/38	35/40	40/40	60/60	60/60					
	C10J	1	7.2/9.6	24.57/32.76	34.7/40.0	83/90	90/90	44/50	45/50	40/40	60/60	60/60					
RHPBZR060AJT	No Heat	—	—	—	—	105/115	110/110	—	—	65/75	70/80	60/60					
	C05J	1	3.6/4.8	12.28/16.38	17.3/20.0	61/65	70/80	22/25	25/25	40/40	60/60	60/60					
	C07J	1	5.4/7.2	18.43/24.57	26.0/30.0	72/77	80/80	33/38	35/40	40/40	60/60	60/60					
	C10J	1	7.2/9.6	24.57/32.76	34.7/40.0	83/90	90/90	44/50	45/50	40/40	60/60	60/60					
RHPBZR060AJT	No Heat	—	—	—	—	126/140	150/150	—	—	87/100	90/100	60/60					
	C05J	1	3.6/4.8	12.28/16.38	17.3/20.0	61/65	70/80	22/25	25/25	40/40	60/60	60/60					
	C07J	1	5.4/7.2	18.43/24.57	26.0/30.0	72/77	80/80	33/38	35/40	40/40	60/60	60/60					
	C10J	1	7.2/9.6	24.57/32.76	34.7/40.0	83/90	90/90	44/50	45/50	40/40	60/60	60/60					

DIMENSIONS

Model	Height "A"
024, 030	29 1/8"
036, 042, 048, 060	37 1/8"

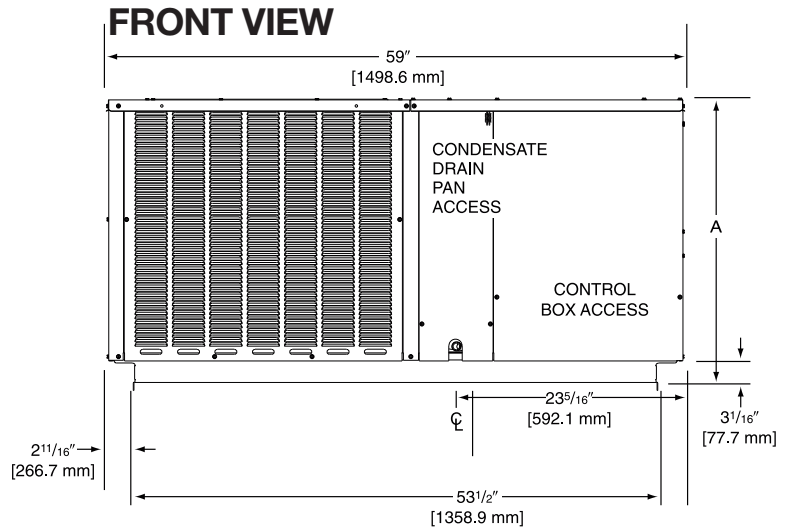

REAR VIEW

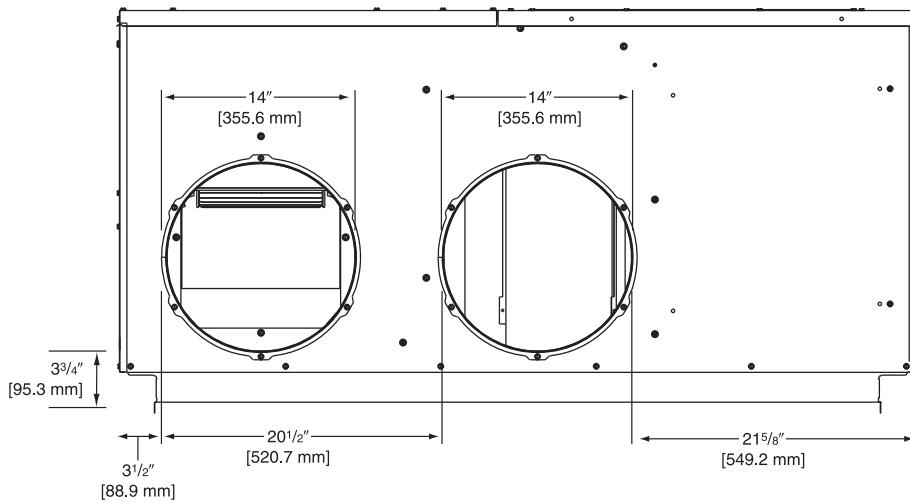

ELECTRICAL CONNECTIONS

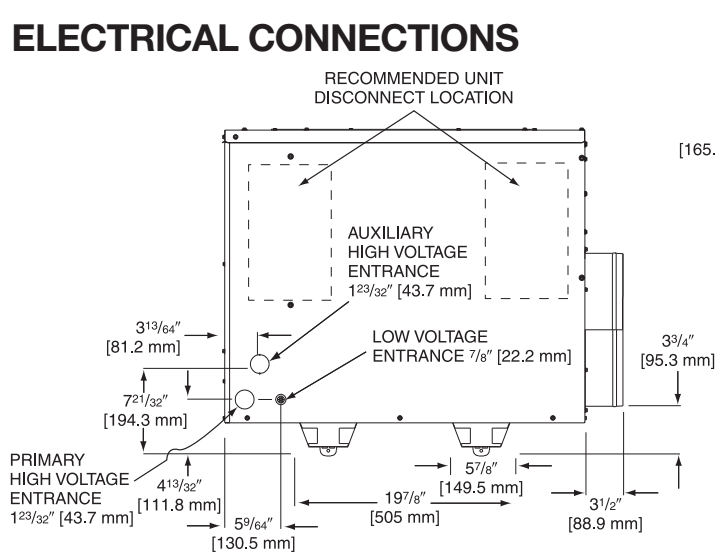

BOTTOM VIEW

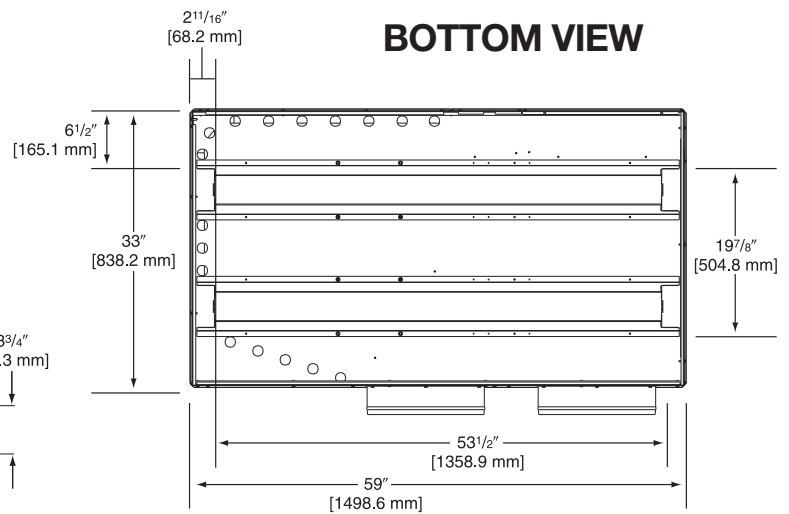

[] Designates Metric Conversions

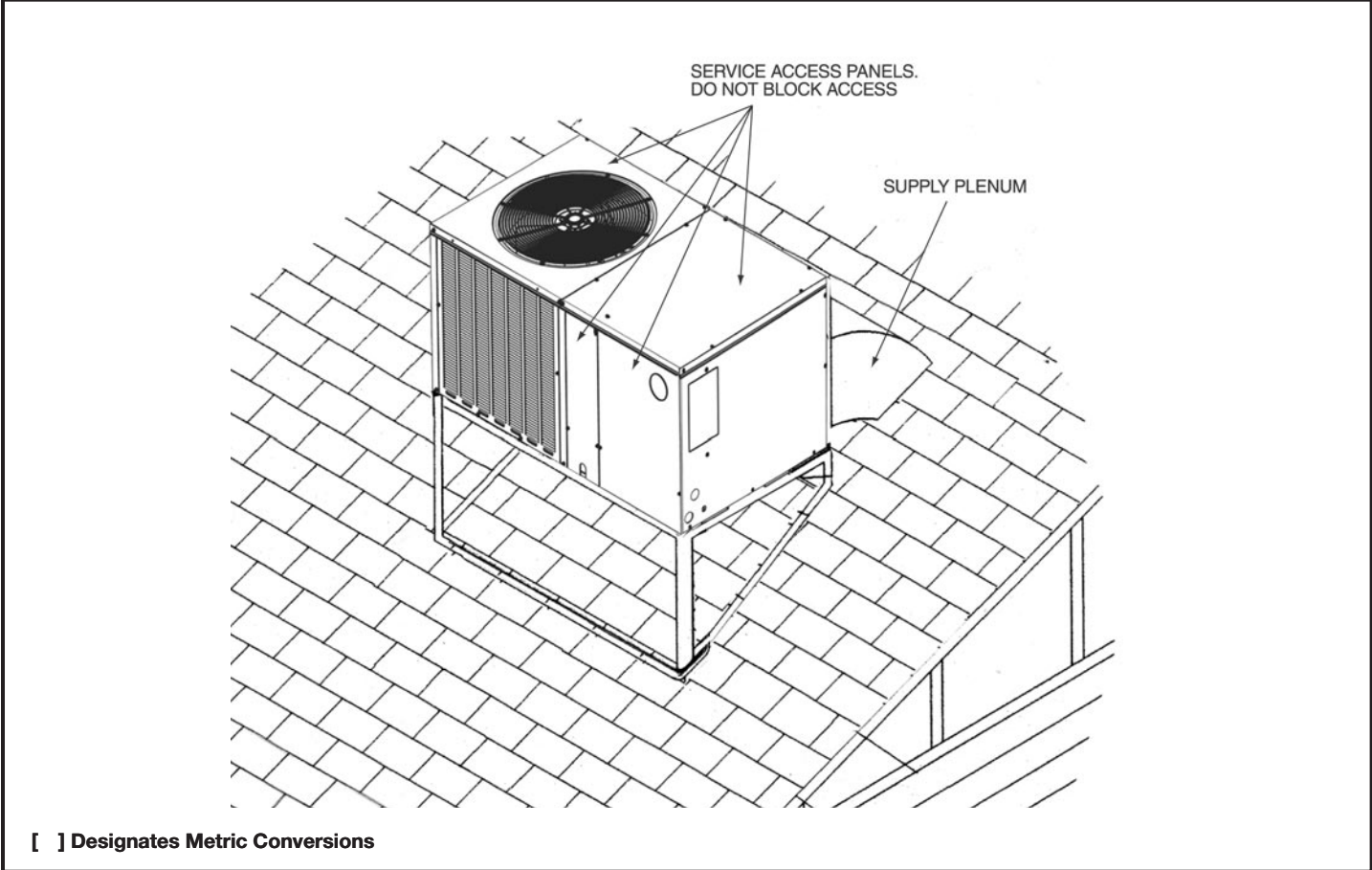
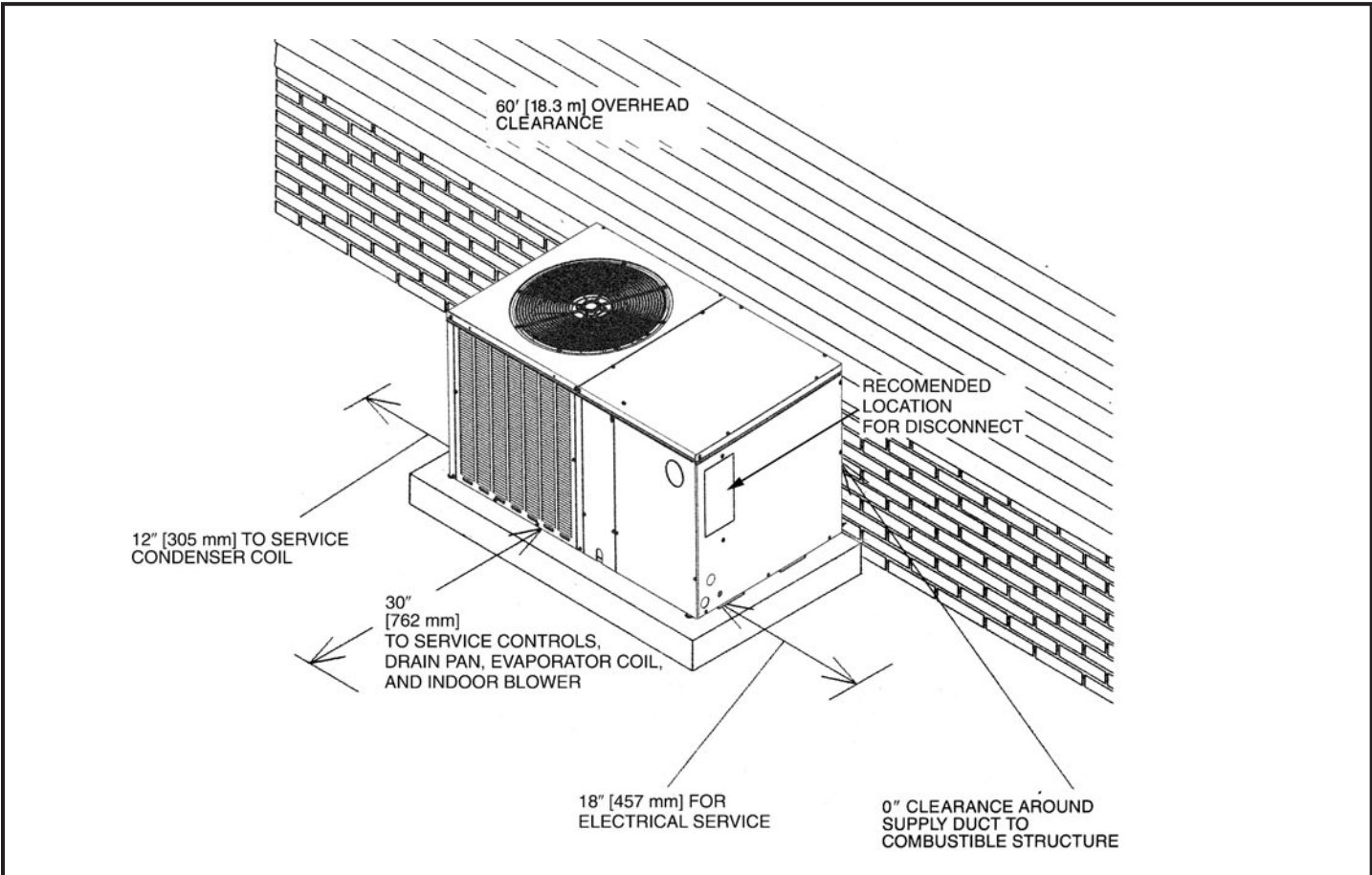

[] Designates Metric Conversions

BEFORE PURCHASING THIS APPLIANCE, READ IMPORTANT ENERGY COST AND EFFICIENCY INFORMATION AVAILABLE FROM YOUR RETAILER.

GENERAL TERMS OF LIMITED WARRANTY*

Mainline® will furnish a replacement for any part of this product which fails in normal use and service within the applicable periods stated, in accordance with the terms of the limited warranty.

***For complete details of the Limited and Conditional Warranties, including applicable terms and conditions, contact your local contractor or the Manufacturer for a copy of the product warranty certificate.**

Conditional Parts (Registration Required)

1 Phase, Residential Applications.....Ten (10) Years

Compressor

1 Phase, Residential Applications.....Ten (10) Years

1 & 3 Phase, Commercial Applications.....Five (5) Years

Parts

1 & 3 Phase, Commercial ApplicationsOne (1) Year

Before proceeding with installation, refer to installation instructions packaged with each model, as well as complying with all Federal, State, Provincial, and Local codes, regulations, and practices.

www.MainlineCollection.com

"In keeping with its policy of continuous progress and product improvement, the right is reserved to make changes without notice."