

725

Thermostat Application Guide

Description	
Gas or Oil Heat	Yes
Electric Furnace	Yes
Heat Pump (No Aux. or Emergency Heat)	Yes
Heat Pump (With Aux. or Emergency Heat)	Yes
Multi-Stage Systems	Yes
Heat Only Systems	Yes
Heat Only Systems - Floor or Wall Furnace	Yes
Cool Only Systems	Yes
Millivolt Conventional Systems	Yes
Two Transformer Systems	No

Power Type

Battery Power
 Hardwire (Common Wire)
 Hardwire (Common Wire) with Battery Backup

A trained, experienced technician must install this product.

Carefully read these instructions. You could damage this product or cause a hazardous condition if you fail to follow these instructions.

Una versión en español de este manual se puede descargar en la página web de la compañía.

Table of Contents

Page

Installation Tips	2-3
Thermostat Quick Reference	4-5
Wiring	6
Wiring Diagrams	7
Features & About The Badge	8
Technician Setup	9-12
Programming Thermostat	13-16

Specifications

The display range of temperature ...	41°F to 95°F (5°C to 35°C)
The control range of temperature....	44°F to 90°F (7°C to 32°C)
Swing (cycle rate or differential)	Heating is adjustable from 0.2° to 2.0° Cooling is adjustable from 0.2° to 2.0°
Power source	18 to 30 VAC, NEC Class II, 50/60 Hz for hardwire Battery power from 2 AA Alkaline batteries
Operating ambient	32°F to +105°F (0°C to +41°C)
Operating humidity	90% non-condensing maximum
Dimensions of thermostat	4.7"W x 4.4"H x 0.8"D

1 © U.S. Registered Trademark. Patents pending
 Copyright © 2019 All Rights Reserved.

Rev. 1918

Wall Locations

The thermostat should be installed approximately 4 to 5 feet above the floor. Select an area with average temperature and good air circulation.

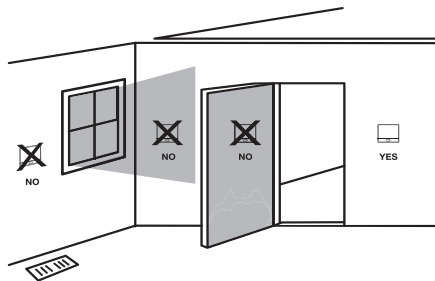

Do not install thermostat in locations:

- Close to hot or cold air ducts
- That are in direct sunlight
- With an outside wall behind the thermostat
- In areas that do not require conditioning
- Where there are dead spots or drafts (in corners or behind doors)
- Where there might be concealed chimneys or pipes



Installation Tip

Pick an installation location that is easy for the user to access. The temperature of the location should be representative of the building.

Subbase Installation

- 1 Horizontal Mount
- 2 Vertical Mount

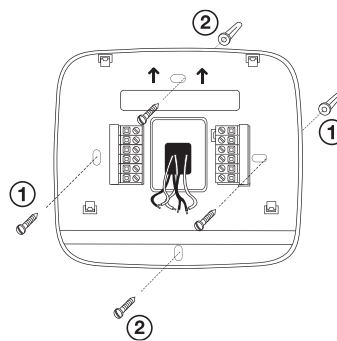

For vertical mount put one screw on the top and one screw on the bottom.
 For horizontal mount put one screw on the left and one screw on the right.



Installation Tip: Electrical Hazard

Failure to disconnect the power before beginning to install this product can cause electrical shock or equipment damage.



Mercury Notice

All of our products are mercury free. However, if the product you are replacing contains mercury, dispose of it properly. Your local waste management authority can give you instructions on recycling and proper disposal.

Installation Tips

Mount Thermostat

Align the 4 tabs on the subbase with corresponding slots on the back of the thermostat, then push gently until the thermostat snaps in place.

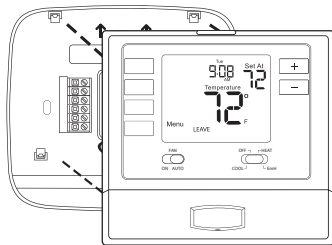

Battery Installation

Battery installation is recommended even if thermostat is hardwired (C terminal connected). When thermostat is hardwired and batteries are installed, the thermostat will activate a compressor delay of 5 minutes when the thermostat detects a power outage from the hardwired power supply.

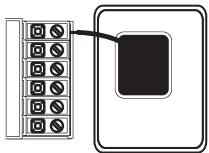

Important:

High quality alkaline batteries are recommended. Rechargeable batteries or low quality batteries do not guarantee a 1-year life span.

Insert 2 AA Alkaline batteries (included). High quality alkaline batteries are recommended.

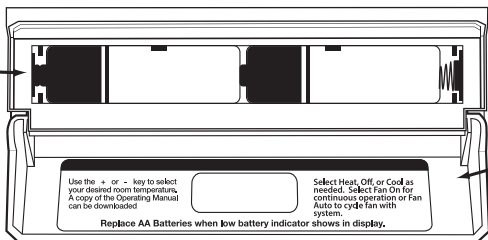

Simple operating instructions are found on the back of the battery door.

Thermostat Quick Reference

Getting to know your thermostat

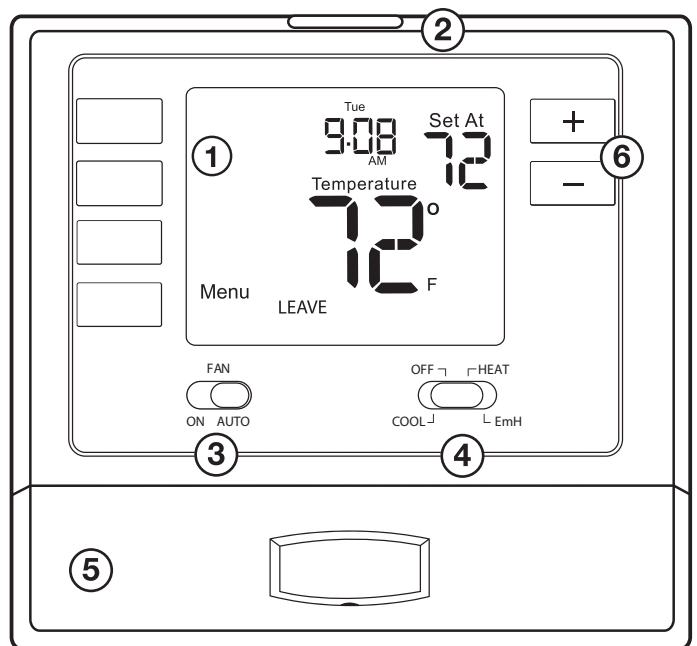

- 1 LCD Display
- 2 Glow in the dark light button
- 3 Fan Switch
- 4 System Switch
- 5 Easy change battery door
- 6 Temperature Setpoint Buttons

Getting to know your thermostat

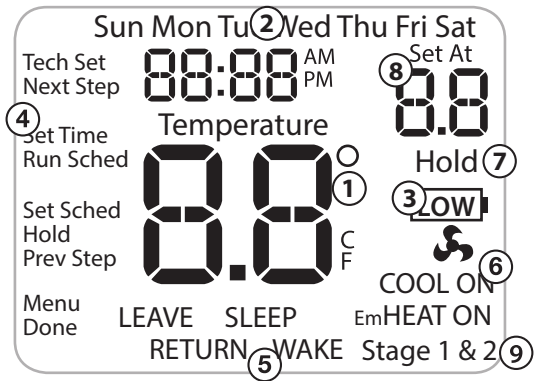

- ① Indicates the current room temperature
- ② Time and day of the week
- ③ **Low Battery Indicator:** Replace batteries when this indicator is shown.
- ④ **Button Options**
- ⑤ **Program Time Periods:** This thermostat has 4 programmable time periods per day.
- ⑥ **System Operation Indicators:** The COOL ON, HEAT ON or icon will display when the COOL, HEAT, or (fan) is on.
Note: The Compressor delay feature is active if these are flashing.
- ⑦ **Hold** is displayed when the thermostat program is permanently overridden.
- ⑧ **Setpoint:** Displays the user selectable setpoint temperature.
- ⑨ **Stages:** Indicates the stages of heat that are active.

Important

The low battery indicator is displayed when the AA battery power is low. If the user fails to replace the battery within 21 days, the screen will only show the low battery indicator but maintain all functionality. If the user fails to replace the batteries after an additional 21 days (days 22-42 since first "low battery" display) the setpoints will change to 55°F (Heating) and 85°F (Cooling). If the user adjusts the setpoint away from either of these, it will hold for 4 hours then return to either 55°F or 85°F. After day 63 the batteries must be replaced immediately to avoid freezing or overheating because the thermostat will shut the unit off until the batteries are changed.

Caution: Electrical Hazard

Failure to disconnect the power before beginning to install this product can cause electrical shock or equipment damage.

Warning:

All components of the control system and the thermostat installation must conform to Class II circuits per the NEC Code.

Wiring

1. If you are replacing a thermostat, make note of the terminal connections on the thermostat that is being replaced. In some cases the wiring connections will not be color coded. For example, the green wire may not be connected to the G terminal.
2. Loosen the terminal block screws. Insert wires then retighten terminal block screws.
3. Place nonflammable insulation into wall opening to prevent drafts.

Installation Tip

Do not overtighten terminal block screws, as this can damage the terminal block. A damaged terminal block can keep the thermostat from fitting on the subbase correctly or cause system operation issues.

Max Torque = 6in-lbs.

Terminal Designations

	Heat Pump System 1 HEAT 1 COOL / 2 HEAT 1 COOL	Conventional System 1 HEAT 1 COOL / 2 HEAT 1 COOL
R	Transformer Power	Transformer Power
C	Transformer Common	Transformer Common
B	Changeover Valve Energized in HEAT	Energized in HEAT
O	Changeover Valve Energized in COOL	Energized in COOL
G	Fan Relay	Fan Relay
W/E	First Stage of Emergency HEAT	First Stage of HEAT
W2	Second Stage of HEAT/ EMERGENCY HEAT	Second Stage of HEAT
Y	First Stage of HEAT and COOL	First Stage of COOL

Tech Settings

Technician Setup Menu

This thermostat has a technician setup menu for easy installer configuration. To setup the thermostat for your particular application:

1. Press the **MENU** button
2. Press and hold **TECH SET** button for 3 seconds. This 3 second delay is designed so that homeowners do not accidentally access the installer settings.
3. Configure the installer options as desired using the table below.

Use the **+** or **-** keys to change settings and the **NEXT STEP** or **PREV STEP** key to move from one step to another. **Note:** Only press the **DONE** key when you want to exit the Technician Setup options.

Tech Settings	LCD Will Show	Adjustment Options	Default
Filter Change Reminder		You can adjust the filter change reminder from OFF to 2000 hours of runtime in 50 hour increments. Tap the second button from the top left side of the thermostat to display the current filter elapsed runtime.	OFF
Room Temperature Calibration		You can adjust the room temperature display to read 4° above or below the factory calibrated reading.	0
Compressor Short Cycle Delay		Selecting "ON" will not allow the compressor to be turned on for 5 minutes after the last time the compressor was switched off. Select "OFF" to remove this delay.	ON

Swing Setting Tip

Temperature swing, sometimes called differential or cycle rate, can be customized for this individual application. For most applications choose a swing setting that is as long as possible without making the occupants uncomfortable.

Tech Settings

Tech Settings	LCD Will Show	Adjustment Options	Default
Cooling Swing		The swing setting often called "cycle rate," "differential" or "anticipation" is adjustable. A smaller swing setting will cause more frequent cycles and a larger swing setting will cause fewer cycles.	0.8
Heating Swing		The swing setting often called "cycle rate," "differential" or "anticipation" is adjustable. A smaller swing setting will cause more frequent cycles and a larger swing setting will cause fewer cycles.	0.8
Heating Setpoint Limit		This feature allows you to set a maximum heat setpoint value. The setpoint temperature cannot be raised above this value.	90
Cooling Setpoint Limit		This feature allows you to set a minimum cool setpoint value. The setpoint temperature cannot be lowered below this value.	44
F or C		Select F for Fahrenheit temperature read out or select C for Celsius read out.	F
12 or 24 Hour Clock		You can select either a 12 or 24 hour clock setting.	12

- 1 Power supply
- 2 Use either O or B terminals for changeover valve.
- 3 Optional 24 VAC common connection when thermostat is used in battery power mode.
- 4 Factory-supplied jumper

2H/1C Heat Pump System - Factory Default Setting

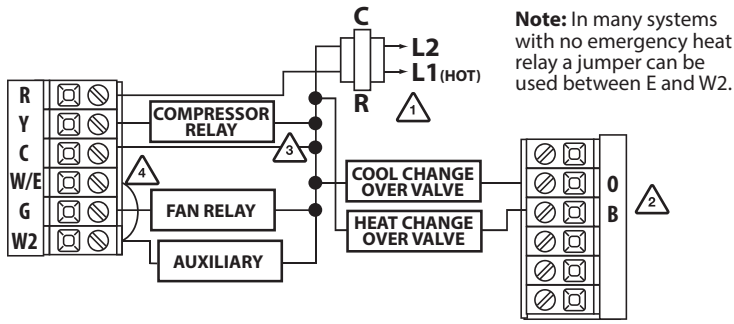

Typical 2H/1C Heat Pump System with separate emergency heat

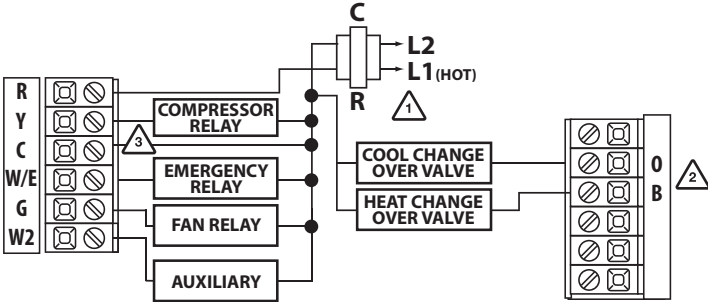

Conventional System 1H/1C, 2H/1C (Heat pump set to "OFF" in tech settings)

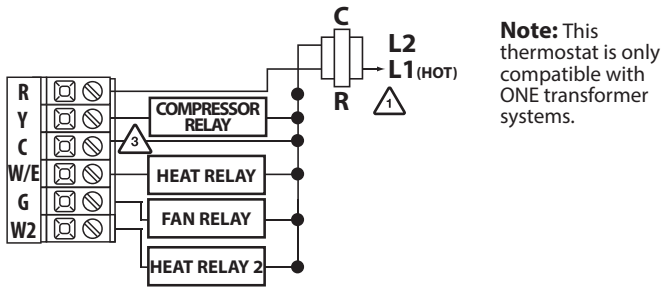

Temporary and Permanent Hold Feature (If using programming)

When cool or heat is turned on, the thermostat will display **HOLD** and **RUN SCHED** on the left of your screen when you press the **+** or **-** button.

Temporary Hold: At this time if you do nothing, the temperature will remain at this setpoint temporarily until next time period.

Permanent Hold: If you press the **HOLD** key on the left of your screen, you will see **HOLD** appear below the setpoint temperature in the display. The thermostat will now permanently stay at this setpoint and can be adjusted using the **+** or **-** keys.

To Return to Running Schedule: Press the **RUN SCHED** button on the left of your screen to exit either temporary or permanent hold.

Filter Change Reminder

If your installing contractor has configured the thermostat to remind you when the air filter needs to be changed, you will see **FILT** in the display when your air filter needs to be changed.

Resetting the filter change reminder: When **FILT** reminder is displayed, you should change your air filter and reset the reminder by holding down the second button from the top left side of the thermostat for 3 seconds.

About The Badge

All of our thermostats use the same universal magnetic badge. Visit the company website to learn more about our free private label program.

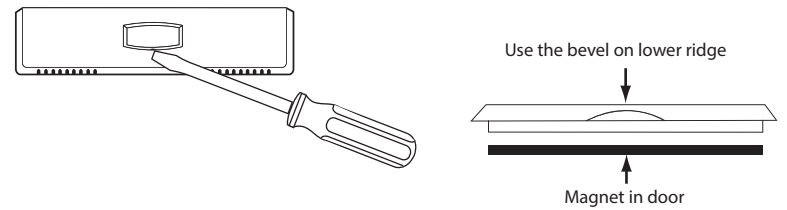

Gently slide a screwdriver into the bottom edge of the badge. Gently turn the screwdriver counter clockwise. The badge is held on by a magnet in the well of the battery door. The badge should pry off easily. **DO NOT USE FORCE.**

7

8

Tech Settings

Tech Settings	LCD Will Show	Adjustment Options	Default
Pro Recovery	REC	Use the + and - key to turn ON or OFF.	ON
Program Options	P-06	Use the + and - key to select 7d for 7 Day, 5d for 5+1+1, or 0d for non programmable.	5d
Heat Pump	HP	ON - Configured to operate heat pump system. OFF - Configured to operate conventional system See page 6 for terminal designations.	ON
Dual Fuel Auxiliary for Heat Pump	RG	OFF Will allow Y(1st stage of Heat) and W2 (Aux Heat) to run together if called for. ON Will de-energize Y terminal 45 seconds after a call for Auxiliary Heat (W2).	OFF

Tech Settings

Tech Settings	LCD Will Show	Adjustment Options	Default
Fan Operation	FA	Select GAS for systems that control the fan during a call for heat. Select ELEC to have the thermostat control the fan during a call for heat.	EL
Emergency Heat Stages	EH	This feature controls the number of stages in Emergency Heat mode. It only appears if the Technician Setup Step for HEAT PUMP is ON.	1
Satisfy Setpoint	SS	This feature allows the thermostat to keep multiple stages of heat energized until setpoint is satisfied.	OFF
Staging Delay	SD	This feature allows a delay to occur when a second stage is needed. This allows the previous stage extra time to satisfy setpoint.	OFF

Set Time (If using programming)

1. With system switch set to OFF, press the **MENU** button
2. Press **SET TIME**
3. Day of the week will be flashing. Use the **+** or **-** key to select the current day of the week.
4. Press **NEXT STEP**
5. The current hour is flashing. Use the **+** or **-** key to select the current hour. When using 12-hour time, make sure the correct a.m. or p.m. choice is selected.
6. Press **NEXT STEP**
7. Minutes are now flashing. Use the **+** or **-** key to select current minutes.
8. Press **DONE** when completed.

Programming

All of our programmable thermostats are shipped with an energy saving pre-program. You can customize this default program by following the steps on page 15.

There are four time periods for each program (**WAKE, LEAVE, RETURN, SLEEP**).

Factory Default Program				
Day of the Week	Events	Time	Setpoint Temperature (HEAT)	Setpoint Temperature (COOL)
Weekday	Wake	6 AM	70°F (21°C)	75°F (24°C)
	Leave	8 AM	62°F (17°C)	83°F (28°C)
	Return	6 PM	70°F (21°C)	75°F (24°C)
	Sleep	10 PM	62°F (17°C)	78°F (26°C)
Saturday	Wake	6 AM	70°F (21°C)	75°F (24°C)
	Leave	8 AM	62°F (17°C)	83°F (28°C)
	Return	6 PM	70°F (21°C)	75°F (24°C)
	Sleep	10 PM	62°F (17°C)	78°F (26°C)
Sunday	Wake	6 AM	70°F (21°C)	75°F (24°C)
	Leave	8 AM	62°F (17°C)	83°F (28°C)
	Return	6 PM	70°F (21°C)	75°F (24°C)
	Sleep	10 PM	62°F (17°C)	78°F (26°C)

Set Program Schedule 5+1+1 or 7 Day

To customize your program schedule, follow these steps:

1. Select **HEAT** or **COOL** with the system switch. **Note:** You have to program heat and cool each separately.
2. Press the **MENU** button (If menu does not appear first press **RUN SCHED**)
3. Press **SET SCHED**. Note: Monday-Friday or (**Monday if in 7 Day**) is displayed and the **WAKE** icon is shown. You are now programming the wake time period for that day.
4. Time is flashing. Use the **+** or **-** key to make your time selection for that day's **WAKE** time period.
5. Press **NEXT STEP**
6. The setpoint temperature is flashing. Use the **+** or **-** key to make your setpoint selection for that day's **WAKE** time period.
7. Press **NEXT STEP**
8. Repeat steps 4 thru 7 for that day's **LEAVE** time period, **RETURN** time period, and **SLEEP** time period.

Saturday:

Repeat steps 4 through 7 for the Saturday **WAKE** time period, **LEAVE** time period, **RETURN** time period, and for the Saturday **SLEEP** time period.

Sunday:

Repeat steps 4 through 7 for the Sunday **WAKE** time period, **LEAVE** time period, **RETURN** time period, and for the Sunday **SLEEP** time period.

Set Program Schedule 5+1+1 or 7 Day (Continue...)



If using 7-Day Programming use previous steps for every individual day.

You can also use these time saving functions. You must be in **Set Sched** Programming Mode (**Press Menu >> Press Set Sched**) for the following functions to work:

- 1) To copy ALL time periods and temperatures of current system and day to ALL days, Press and Hold 2nd button down on left until the Days and Time flash.
- 2) To copy ALL time periods (only times) for ALL days to the opposite system (Heat to Cool / Cool to Heat), Press and hold the Glow in the Dark Light button down until Set Time and Time flash.

Operation Manual

Operation Manual

Table of Contents	Page
Table of Contents	1
Thermostat Operation	2-3
Thermostat Quick Reference	4-7
Programming	8-10
Warranty Information	11



Caution:

Equipment damage hazard. Do not operate the cooling system if the outdoor temperature is below 50°F (10°C) to prevent possible compressor damage.

Una version en español de este manual se puede descargar en la pagina web de la compañía.

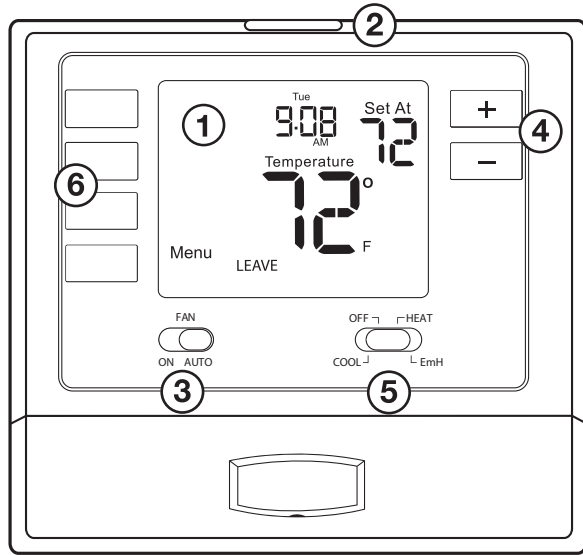

- ① LCD Display
- ② Glow in the dark light button
- ③ Fan Switch
- ④ Temperature Setpoint Buttons
- ⑤ System Switch
- ⑥ User Buttons



- ① **LCD Display**
See page 4 for details about this display read out.
- ② **Glow in the dark light button**
The glow in the dark light button will self illuminate for several hours after exposure to ambient light. This button turns on the display light when pressed.
- ③ **Fan Switch**
Select **ON** or **AUTO**. **ON** will run the fan continuously. **AUTO** will cycle the fan on only when the heating or cooling system is on.
- ④ **Temperature Setpoint Buttons**
Press the + or - buttons to select the desired room temperature.
- ⑤ **System Switch**
Selects the operation mode on your HVAC system. Selecting **HEAT** turns on the heat mode. Selecting **COOL** turns on the cool mode. Selecting **OFF** turns both heating and cooling off. Selecting **EmH** (for heat pumps with auxiliary heat) will lockout the compressor and control emergency/ auxiliary heat.
- ⑥ **User Buttons**
Use these buttons to set up your programming options. Refer to the next page for detail.

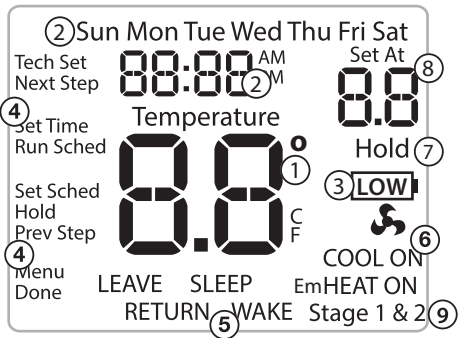

Caution:

When the battery icon **LOW** appears replace your AA batteries immediately. Failure to do so may result in your heating & cooling system becoming inoperable. Freezing or over heating can occur.



- ① **Indicates the current room temperature**
- ② **Time and day of the week**
- ③ **Low Battery Indicator:** Replace batteries when this indicator is shown.
- ④ **Button Options**
- ⑤ **Program Time Periods:** This thermostat has 4 programmable time periods per day.
- ⑥ **System Operation Indicators:**
The COOL ON, HEAT ON or  icon will display when the COOL, HEAT, or  (fan) is on.
Note: The Compressor delay feature is active if these are flashing.
- ⑦ **Hold** is displayed when the thermostat program is permanently overridden.
- ⑧ **Setpoint:** Displays the user selectable setpoint temperature.
- ⑨ **Stages:** Indicates the stages of heat that are active.



Important:

The low battery indicator is displayed when the AA battery power is low. If the user fails to replace the battery within 21 days, the screen will only show the low battery indicator but maintain all functionality. If the user fails to replace the batteries after an additional 21 days (days 22-42 since first “low battery” display) the set points will change to 55°F (Heating) and 85°F (Cooling). If the user adjusts these setpoints away from these it will hold for 4 hours then return to either 55°F or 85°F. After day 63 the batteries must be replaced immediately to avoid freezing or overheating because the thermostat will shut the unit off until the battery is changed.

Battery Door Information

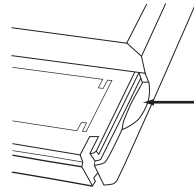

Replace with 2 AA Alkaline Batteries. High quality Alkaline batteries are recommended.

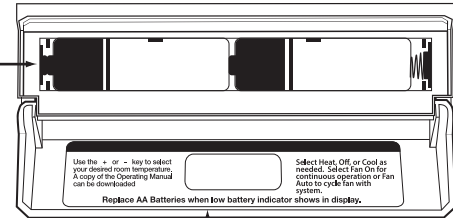

Use the finger bevel on the lower portion of the thermostat to open the easy access battery door.

Simple operating instructions are found on the back of the battery door.

Temporary and Permanent Hold Feature

Temporary Hold: The thermostat will display **HOLD** and **RUN SCHED** on the left of your screen when you press the **+** or **-** key. If you do nothing, the temperature will remain at this setpoint temporarily until next time period. Your program setpoint will then replace your temporary setpoint.

Permanent Hold: If you press the **HOLD** key at the left of your screen, you will see **HOLD** appear below the setpoint temperature in the display. The thermostat will now permanently stay at this setpoint and can be adjusted using the **+** or **-** keys.

To return to program: Press the **RUN SCHED** key at the left of your screen to exit either temporary or permanent hold.

Understanding Your Thermostats Staging:

This thermostat controls 2 stages of heating. For reasons of energy efficiency the thermostat will try to maintain your comfort setting using only 1 stage. If the 2nd stage is necessary it will be used and you will see Stage 2 in the display.

Filter Change Reminder





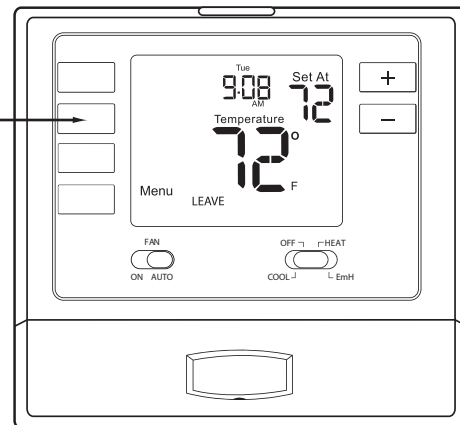

If your HVAC contractor has configured the thermostat to remind you when the air filter needs to be changed, you will see **FILT** in the display when your air filter needs to be changed.

Resetting the filter change reminder: When **FILT** reminder is displayed, you should change your air filter and reset the reminder by holding down the second button from the top left side of the thermostat for 3 seconds.

Hold down 3 seconds, to reset filter reminder.







Set Time

1. With system switch set to OFF, press the **MENU** button
2. Press **SET TIME**
3. Day of the week will be flashing. Use the  or  key to select the current day of the week.
4. Press **NEXT STEP**
5. The current hour is flashing. Use the  or  key to select the current hour. When using 12-hour time, make sure the correct a.m. or p.m. choice is selected.
6. Press **NEXT STEP**
7. Minutes are now flashing. Use the  or  key to select current minutes.
8. Press **DONE** when completed.

Set Program Schedule 5+1+1 or 7 Day

To customize your program schedule, follow these steps:

1. Select **HEAT** or **COOL** with the system switch. **Note:** You have to program heat and cool each separately.
2. Press the **MENU** button (If menu does not appear first press **RUN SCHED**)
3. Press **SET SCHED**. Note: Monday-Friday or (**Monday if in 7 Day**) is displayed and the **WAKE** icon is shown. You are now programming the wake time period for that day.
4. Time is flashing. Use the  or  key to make your time selection for that day's **WAKE** time period.
5. Press **NEXT STEP**
6. The setpoint temperature is flashing. Use the  or  key to make your setpoint selection for that day's **WAKE** time period.
7. Press **NEXT STEP**
8. Repeat steps 4 thru 7 for that day's **LEAVE** time period, **RETURN** time period, and **SLEEP** time period.

Set Program Schedule 5+1+1 or 7 Day (Continue...)

Saturday:

Repeat steps 4 through 7 for the Saturday **WAKE** time period, **LEAVE** time period, **RETURN** time period, and for the Saturday **SLEEP** time period.

Sunday:

Repeat steps 4 through 7 for the Sunday **WAKE** time period, **LEAVE** time period, **RETURN** time period, and for the Sunday **SLEEP** time period.



If using 7-Day Programming use previous steps for every individual day.

You can also use these time saving functions. You must be in **Set Sched** Programming Mode (**Press Menu >> Press Set Sched**) for the following functions to work:

- 1) To copy ALL time periods and temperatures of current system and day to ALL days, Press and Hold 2nd button down on left until the Days and Time flash.
- 2) To copy ALL time periods (only times) for ALL days to the opposite system (Heat to Cool / Cool to Heat), Press and hold the Glow in the Dark Light button down until Set Time and Time flash.

Warranty Registration

Your new thermostat has a 5 year limited warranty. You must register your thermostat within 60 days of installation. Without this registration the warranty period will begin on date of manufacture. For warranty issues please contact the HVAC professional that installed this product. You can register your new thermostat in 2 ways:

Online

Go to the company website, select warranty registration and fill out a short registration form.

Mail

Complete the form below and mail it to the address shown.

Warranty Registration

Name: _____ Thermostat Model: _____

Address: _____ Date Installed: _____

City: _____ Complete form and mail to:

State: _____ **Thermostat Warranty Registration**

Zip: _____ Pro1iaq

P.O. Box 3377
Springfield, MO 65808-3377

**Cut Out For
Warranty Registration**

