

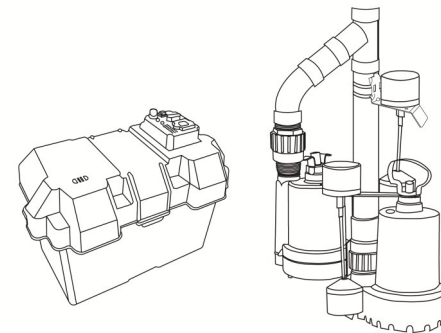

*The Pump Authority.*

**INSTALLATION & OPERATION  
MANUAL  
PRE-ASSEMBLED PRIMARY & BATTERY  
BACKUP SUMP PUMP SYSTEM  
Model:  
MLP72941**





*The Pump Authority.*





## Safety Guidelines

Carefully read, understand and follow all safety instructions in this manual.

 This is the safety alert symbol. When you see this symbol, look for one of the following signal words.

 **DANGER** Indicates a hazardous situation which, if not avoided, will result in death or serious injury.

 **CAUTION** Indicates a hazardous situation which, if not avoided, could result in death or serious injury.

 **WARNING** Indicates a hazardous situation which, if not avoided, could result in minor or moderate injury.

## Safety Information

Read these warnings carefully. Know the application and limitations of this pump. Failure to follow these warnings could result in serious bodily injury and/or property damage.

 **DANGER** RISK OF ELECTRICAL SHOCK. Disconnect and lockout power supply before removing old pump or installing or servicing this pump.

 **DANGER** RISK OF ELECTRICAL SHOCK. This pump is supplied with a grounding conductor and grounding type attachment plug. To reduce the risk of electric shock, be certain that it is connected only to a properly grounded, grounding type receptacle. For added safety, it is highly recommended to connect this pump to a GFCI (Ground Fault Circuit Interrupter) outlet. Connect only to a receptacle that is adequately rated for the voltage and amperage of this pump

 **WARNING** The installation of this pump must be in accordance with the National Electric Code (NEC), Uniform Plumbing Code (UPC), International Plumbing Code (IPC) as well as all applicable local codes and ordinances.

 **CAUTION** Do not install this pump in any location classified as hazardous by the National Electrical Code, ANSI/NFPA70.

 **CAUTION** Do not use this pump to pump flammable or explosive fluids such as gasoline, kerosene, etc. Do not use this pump in flammable or explosive environments. Use only with liquids compatible with pump component materials.

 **WARNING** RISK OF ELECTRICAL SHOCK. This pump has not been investigated for use in swimming pool or marine areas.

 **WARNING** RISK OF ELECTRICAL SHOCK. **DO NOT** use the power cord to remove or lower the pump into the basin. The cord may pull apart exposing bare wires which could cause a fire or electrical shock. Use the handle supplied with the pump for installing and removing the pump from the basin.

 **WARNING** Do not run the pump dry. This pump relies on water for cooling. Running the pump dry can cause the pump to overheat and the possibility of burns to anyone that handles the pump. Running the pump dry will void the warranty.

 **WARNING** Don't expose pump to freezing temperatures. Discharge lines exposed to freezing temperatures should be positioned with a downward slope to prevent freezing.

## LIMITED WARRANTY - PRIMARY/BATTERY BACKUP PUMPS:

Manufacturer warrants the products specified in this warranty to be free from defects in material or workmanship for five (5) years from date of purchase. During the time period and subject to the terms and conditions, the manufacturer will repair or replace to the original user or consumer any portion of this product which proves to be defective due to materials or workmanship. At all times the manufacturer shall have and possess the sole right and option to determine whether to repair or replace defective equipment, parts, or components. The manufacturer has the option to inspect any product returned under warranty to confirm that the warranty applies before repair or replacement under warranty is approved. This warranty sets forth the manufacturer's sole obligation and purchaser's exclusive remedy for defective product. Return defective product to the place of purchase for warranty consideration.

## WARRANTY PERIOD - PRODUCTS:

If, within the duration of product use by the original user, this product proves to be defective due to materials or workmanship, the product shall be repaired or replaced at the manufacturer's option, subject to the terms and conditions set forth in this warranty statement. Proof of purchase is required for warranty consideration. In the absence of suitable proof of the purchase date, the effective period of this warranty is 12 months from the product's date of manufacture.

## LABOR, ETC. COSTS:

The manufacturer shall IN NO EVENT be responsible or liable for the cost of field labor or other charges incurred by any customer in removing and/or affixing any product, part, or component thereof.

## PRODUCT IMPROVEMENTS:

The manufacturer reserves the right to change or improve its products or any portions thereof without being obligated to provide such a change or improvement for units sold and/or shipped prior to such change or improvement.

## GENERAL TERMS AND CONDITIONS:

This warranty shall not apply to damage due to acts of God, normal wear and tear, normal maintenance services and the parts used in connection with such service, lightning or conditions beyond the control of the manufacturer, nor shall it apply to products which, in the sole judgment of the manufacturer, have been subject to negligence, abuse, accident, misapplication, tampering, alteration; nor due to improper installation, operation, maintenance or storage; nor to excess of recommended maximums as set forth in the instructions. Warranty will be VOID if any of the following conditions are found:

1. Product is used for purposes other than those for which it was designed and manufactured
2. Product not installed in accordance with applicable codes, ordinances, and good trade practices
3. Product connected to voltage other than indicated on nameplate or labels
4. Pump exposed to but not limited to the following: sand, gravel, cement, grease, plaster, mud, tar, oil, gasoline, solvents or other abrasive or corrosive substances
5. Pump has been used for pumping liquids above 120°F
6. Pump allowed to operate dry (liquid supply cut off)

## DISCLAIMER:

Any oral statements about the product made by the seller, the manufacturer, the representatives, or any other parties do not constitute warranties, shall not be relied upon by the user, and are not part of the contract for sale. Seller's and the manufacturers only obligation, and buyer's only remedy, shall be the replacement and/or repair by the manufacturer of the product as described above. NEITHER SELLER NOR THE MANUFACTURER SHALL BE LIABLE FOR ANY INJURY, LOSS OR DAMAGE, DIRECT, INCIDENTAL OR CONSEQUENTIAL (INCLUDING, BUT NOT LIMITED TO, INCIDENTAL OR CONSEQUENTIAL DAMAGES FOR LOST PROFITS, LOST SALES, INJURY TO PERSON OR PROPERTY, OR ANY OTHER INCIDENTAL OR CONSEQUENTIAL LOSS), ARISING OUT OF THE USE OR THE INABILITY TO USE THE PRODUCT, AND THE USER AGREES THAT NO OTHER REMEDY SHALL BE AVAILABLE TO IT. Before using, the user shall determine the suitability of the product for his/her intended use, and user assumes all risk and liability whatsoever in connection therewith.

THE WARRANTY AND REMEDY DESCRIBED IN THIS LIMITED WARRANTY IS AN EXCLUSIVE WARRANTY AND REMEDY AND IS IN LIEU OF ANY OTHER WARRANTY OR REMEDY, EXPRESSED OR IMPLIED, WHICH OTHER WARRANTIES AND REMEDIES ARE HEREBY EXPRESSLY EXCLUDED, INCLUDING BUT NOT LIMITED TO ANY IMPLIED WARRANTY OF MERCHANTABILITY OR FITNESS FOR A PARTICULAR PURPOSE, TO THE EXTENT EITHER APPLIES TO A PRODUCT SHALL BE LIMITED IN DURATION TO THE PERIODS OF THE EXPRESSED WARRANTIES GIVEN ABOVE.

Some states and countries do not allow the exclusion or limitations on how long an implied warranty lasts or the exclusion or limitation of incidental or consequential damages, so the above exclusion or limitations may not apply to you. This warranty gives you specific legal rights, and you may also have other rights which vary from state to state.

*\*Effective July 1, 2023, due to an update in California law, the start date for product warranties will now be aligned with the date of delivery of the product. This change is for all Mainline products purchased on or after July 1, 2023 by California consumers. (California Legislative Information AB-2912)*



## Description

This primary/battery backup pump system is designed to remove water from residential sump basins. The all in one kit is pre-assembled for easy installation and includes a 1/3 HP primary pump and 12 volt back up pump. Each pump has a vertical float switch and 10' power cord.

## Specifications

Model	Primary Pump MLP72341	12 Volt Backup Pump MLP92910
HP	1/3	n/a
Volts	120 volt AC	12 volt DC
Amps	4.1 Amps	13 Amps
Hz	60 Hz	n/a
Phase	1	n/a
Discharge Size	1-1/2" FNPT	1-1/4" or 1/2" NPT
Max. Solids Handling	3/8"	1/8"
Liquid Temperature Range	32°F - 120°F	32°F - 120°F
Cord Length	10'	10'
Switch Type	Vertical	Vertical
Switch on Level (Factory Set)	7"	10"
Switch off Level (Factory Set)	3"	8"
Pump Housing Construction	Cast Iron	Thermoplastic
Pump Base Construction	Cast Iron	Thermoplastic
Impeller	Stainless Steel	Thermoplastic
Motor Shaft	Stainless Steel	Stainless Steel
Shaft Seal	Carbon/Ceramic/ Stainless Steel	Carbon/Ceramic/ Stainless Steel
Fasteners	Stainless Steel	Stainless Steel
Shut off head	26'	21'
Max. PSI	10.8	9.0
Battery Charger	n/a	2 Amp
Low Voltage Cutoff	n/a	10 volts

## Replacement Parts

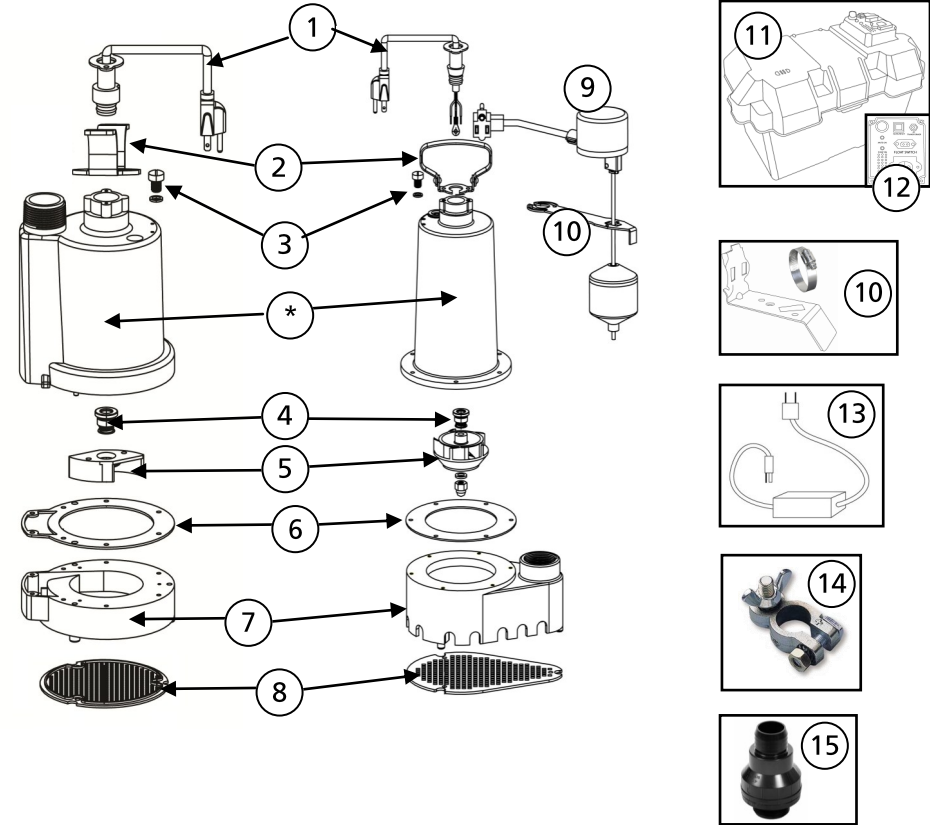

Ref #	Description	MLP72910	MPL72341
1	Power Cord	99158	99108
2	Handle	99051	99053
3	Oil Fill Plug with O-ring	99056	99056
4	Shaft Seal	99057	99057
5	Impeller	99060	99096
6	Gasket	99062	99088
7	Volute/Base	99067	99078
8	Intake Screen	99073	99073
9	Vertical Float Switch (includes switch, float rod, float ball & grommet)	92091	92010
10	Vertical Float Switch Bracket	99195	99105
*If motor fails, replace entire pump			
11	Battery Box (Complete Unit)	99464	
12	Control Panel (no cover)	99465	
13	AC Adapter	99467	
14	Battery Terminals (+ & -) One Set	99460	
15	Check Valve	99507	99509

## Troubleshooting (12 Volt Backup Pump)

PROBLEM	POSSIBLE CAUSES	HOW TO CORRECT
Pump won't run.	Loose, corroded or reversed wire connections	Tighten, clean or reconnect if necessary
	Discharged battery	Charge battery
Pump hums but won't run.	Defective battery	Replace battery
	Blown fuse	Replace with 20 amp fuse
	Float switch is stuck	Position float so it moves freely
	Battery is discharged below 10 volts	Fully charge battery
Pump cycles too often	Float switch positioned improperly	Reposition float switch
	Defective or missing check valve	Install or replace check valve
Pump runs but moves little or no water	Low or discharged battery	Fully charge battery
	Obstruction in pipe	Clear obstruction
	Discharge pipe height/length exceeds the capacity of this pump	Check performance section for capacity of this pump
	Defective check valve	Replace Check Valve if necessary

## Troubleshooting (120 Volt Primary Pump)

PROBLEM	POSSIBLE CAUSES	HOW TO CORRECT
If the pump does not start or run	Pump is not plugged in, switch or breaker is off	Plug pump in or turn on switch/breaker
	Check for blown fuses or tripped circuit breakers or tripped GFCI outlets	Replace fuse, reset breaker, reset GFCI outlet
	Float switch is defective	Check and replace if necessary
	Motor thermal protector tripped	Allow pump to cool. Pump will reset
	Float switch is stuck or obstructed	Remove obstruction or position pump so it will not become stuck
The pump starts and stops too often	Backflow of water from discharge hose/pipe	Install or replace check valve
	Float switch is defective	Replace float switch
If the pump runs but moves little or no water	Clogged intake screen	Clean or replace screen
	Clogged discharge hose/pipe	Remove clog
	Frozen discharge hose/pipe	Allow hose/pipe to thaw
	Pump is air locked	Clean out airlock hole with a paper clip or pipe cleaner
	Low line voltage	Check wire size and increase if necessary
	Check valve is stuck in the closed position	Inspect, repair or replace if necessary
	Check valve is installed backwards	Make sure check valve is installed in the correct direction of flow
	Worn, damaged or clogged pump parts	Inspect for wear, damage or clog and clean or replace if necessary
Discharge head exceeds pump capacity	If pumping height is over 25', the pump will not move water. See performance chart	
Pump does not shut off	Float switch is obstructed or stuck	Remove obstruction
	Defective Float Switch	Replace switch

## Battery Requirements

This system is designed to work with 12 volt, lead-acid deep cycle marine / RV batteries. Either a flooded cell (serviceable or maintenance free) or sealed AGM battery are acceptable. Although most deep cycle batteries will work with this pump, it is recommended to use a battery with a minimum 90 amp-hour rating and a 175 minute reserve capacity or larger. Avoid using automobile batteries as these types of batteries are not intended to be charged/discharged for extended periods of time. The Battery case will hold size 24 or 27 batteries.

During prolonged periods of power failure or in an emergency, your automobile battery may be used. Make sure to replace the deep cycle battery as soon as possible as the automobile battery will be quickly ruined by the continuous charge/discharge cycles.

## Carbon Monoxide (CO) Detectors

All backup pump systems that use lead acid batteries, regardless of brand, give off gaseous by-products when the battery is charging. Some of these by-products can cause a carbon monoxide (CO) detector to give a false alarm. When installing this system, position the battery as far away from the CO detector as possible. **DO NOT** move or remove CO detectors from their original location. Always follow the instructions that accompany your CO detector.

If your CO detector alarm sounds, take the following actions.

1. Take immediate action for personal safety as outlined in the CO detector manual.
2. Contact the appropriate utility agency to determine if the CO is coming from your furnace, water heater or other appliance that uses natural gas

If it's determined that a charging battery is causing the CO detector to activate, contact the manufacturer for recommendations on how to alleviate the problem.

## Installation

1. This primary/backup pump kit comes completely assembled. To install, simply place the pump assembly in the in the bottom of your basin and connect to your new or existing discharge pipe. The pump should be placed on a solid foundation. Do not place the pump directly on the ground or sandy or rocky surfaces. Sand and small stones may clog or cause damage to your pump.
2. Install this pump making sure that the float switches will operate freely without coming in contact with the sides of the sump basin. Contact with the side of the sump basin may cause the switch to malfunction. See figure below.

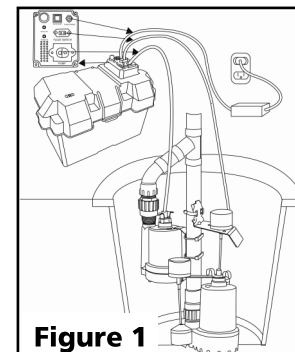

Figure 1

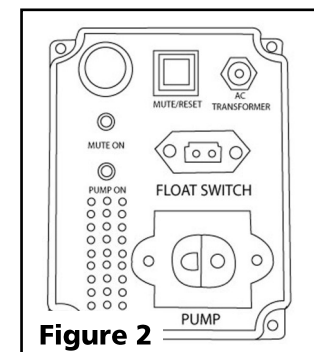
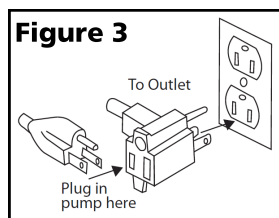

Figure 2

## Installation

### Electrical Connections

1. If necessary, attach the provided battery terminals to the battery. (Many deep cycle marine batteries come with a threaded post terminal built in.) **NOTE:** The provided battery terminals are labeled (+) positive and (-) negative. Make sure the terminals are connected to the proper terminal on the battery. Place the battery in the battery box.
2. Connect the battery lead wires from the control panel to the corresponding terminals on the battery. Connect the red (+) positive lead to the positive battery terminal and tighten the wing nut. Connect the black (-) negative lead to the negative battery terminal and tighten the wing nut. Secure the battery box cover to the lower case.
3. Connect the pump power cord, the float switch and the AC adapter to the corresponding receptacles on the control panel. Make sure they are fully seated in the receptacles.
4. Plug the primary pump float switch plug into a grounded outlet. Next plug the primary pump plug into the piggy back plug of the float switch. See Figure 3
5. Plug the AC adapter into the wall outlet and turn the power back on.
6. Test both pumps by lifting and holding the float switches in the "UP" position. The alarm will sound and the "PUMP ON" light on the control panel will illuminate. The pump should start immediately after lifting the float. If it does not run, check your connections and retry.
7. Test the "MUTE" button when the alarm is sounding. Press once to mute the alarm. The MUTE ON light should illuminate. Press again to re-activate the alarm.



### Operation

1. Once your installation and wiring connections are complete, unplug or disconnect the power to the primary pump.
2. Fill the basin using buckets or a hose. Observe the float switches to make sure they are positioned properly when the basin is filling. Fill the basin until the backup float switch activates the alarm. The backup pump should start and drain the basin.
3. Make any necessary adjustments to the float switches and/or pumps at this time.
4. When the power fails or if the primary pump malfunctions, the back-up pump will automatically start. The back up pump will operate for many hours intermittently. During prolonged periods of power outage the pump may stop pumping when the battery voltage drops below 10 volts. When this happens the alarm will sound signaling that the voltage is too low to operate the pump.
5. This unit is equipped with a 2 amp charger. It will charge a discharged battery at a rate of 2 Ah (Amp hours). Once the battery reaches a full charge, the charger will gradually reduce the charge rate. It will also maintain a charged battery by periodically checking the voltage of the battery.
6. The charger is equipped with over charge protection. It will not let the battery become over charged.

## Maintenance

**⚠ DANGER** Risk of electric shock. Always disconnect the power supply before attempting to install, service or perform maintenance on the pump.

**⚠ WARNING** All repairs must be made by an authorized service center.

**⚠ CAUTION** The primary sump pump contains oil which may become pressurized and hot under normal operating conditions - allow the pump to cool for 2-3 hours before servicing.

1. The pump motor is hermetically sealed in the housing and does not require any service. Disassembly of the motor housing or modification of the power cord voids the warranty.
2. Periodically check the sump basin for accumulation of mud, silt, sand and foreign objects. Clean the basin as needed to prevent damage or clogging of the pump.
3. Periodically inspect and clean the anti-airlock hole.
4. Inspect the float switch for any accumulated debris that may inhibit it from operating properly. Clean if necessary.
5. In applications where the pump may not activate for extended periods of time, it is recommended to cycle the pump at least once per month to ensure the pumping system is working properly when needed.

### Performances

Height and/or piping restriction will reduce the pump output performance. It is recommended to use the same size or larger pipe as the pump discharge for optimum performance.

Model	Discharge Height	0'	5'	10'	15'	20'	25'
MLP72910* 12 Volt	Gallons Per Minute	23	22	18	13	8	
MLP72911 120 Volt	Gallons Per Minute	46	36	30	25	12	1

Performance ratings are based on using a 27M, 12 volt deep cycle marine battery with a 100 Ah rating